



LIQUID LEAK DETECTION SYSTEMS

OPERATION & INSTALLATION MANUAL

DIGITAL UNIT:

FG-NET



CONTENT

DESCRIPTION	4
CERTIFICATIONS	5
CHAPTER I: FG-NET DIGITAL UNIT INSTALLATION	7
1. MOUNTING THE FG-NET DIGITAL UNIT: E AND F	7
2. ELECTRICAL CHARACTERISTICS	8
3. ELECTRICAL CONNECTION OF THE FG-NET DIGITAL UNIT	10
3.1. Connecting the FG-NET Digital Unit to the earth	10
3.2. Connecting the power supply cable	11
3.3. Connecting the leader cable FG-CLC	13
3.4. Connecting the internal relays	14
3.5. Connecting the serial cable	15
3.6. Closing the FG-NET F Digital Unit	15
CHAPTER II: CABLE AND ACCESSORIES INSTALLATION	16
1. INSTALLING ADDRESSABLE SENSE CABLES	16
1.1. Hold-down adhesive clips	16
1.2. Installing sense cables: FG-EC, FG-AC and FG-ECX	17
1.3. Installing hydrocarbon and solvent sense cables: FG-OD	17
1.4. Labelling with tags	19
2. INSTALLING FG-NC JUMPER CABLES	20
3. INSTALLING CONNECTION ACCESSORIES	26
3.1. FG-DTM - Modbus Interface	26
3.2. FG-DTCS - Addressable Box	29
3.3. FG-DCTL – “Cut-to-Length” Addressable Box	30
3.4. FG-DTC - TTK Bus Diversion	32
3.5. FG-DOD - OD Bus Interface	34
3.6. Installing end termination plugs	35
CHAPTER III: DIGITAL UNIT STARTUP	36
1. FG-NET DIGITAL UNIT – POWERING ON	36
2. MENUS	37
2.1. Setup	37

2.2.	Events log	50
2.3.	Cables	52
2.4.	Help	61
2.5.	SD Card	64
3.	WATCHDOG	67
4.	COMMUNICATION SETUP	68
4.1.	General	68
4.2.	Schematics	69
4.3.	Modbus communication	71
4.4.	TOPSurveillance™ Software	74
CHAPTER IV: EXTERNAL DEVICES		77
1.	FG-RELAYS	77
2.	FG-BBOX	79
CHAPTER V: TEST PROCEDURES		83
1.	LEAK TESTS	83
2.	CABLE BREAK TESTS	86
3.	FG-NET MAP	87
CHAPTER VI: MAINTENANCE – FAULT FINDING		89
1.	CHECKING THE SYSTEM	89
2.	SYSTEM MAINTENANCE	89
2.1.	Replacing a sense cable	89
2.2.	Precautions for use and storage	90
2.3.	Adding sense cables to an existing circuit	90
2.4.	Addition of a New Circuit of Sense Cables (Circuits no.2 and/or no.3)	91
2.5.	Removal of the system	91
3.	TROUBLE SHOOTING GUIDE	92
Appendix		96
1.	Digital Unit connection diagram and ratings: FG-NET E / F	96
2.	Modbus Table	97
3.	Commissioning guide	98

DESCRIPTION

The FG-NET Digital system ensures an immediate detection and the precise location of any liquid leaks (water, acids, bases, solvents, hydrocarbons) in both industrial applications and buildings.

The FG-NET system is composed of an FG-NET Digital Unit, plus lengths of sense cables and accessories.

The FG-NET Digital Unit is designed to be used with TTK digital sense cables FG-EC (water and bases), FG-AC (acids), or FG-OD (hydrocarbons and solvents). Different types of sense cables can be connected on the same unit.

The presence of liquid on the sense cable triggers an audible alarm and activates the relevant relays. The 7" (175mm) touch screen display shows the location of the leak to the nearest metre and details of the fault in text format; an interactive installation plan (optional) highlights the location of the fault in real time.

Each sense cable comes equipped with a microchip at the female connector end. The Digital Unit questions each cable successively; the microchip then digitally transmits the 'state' of the cable to the Digital Unit. Due to the autonomy of each cable, several faults can be detected at the same time within the same circuit.

A Digital Unit can manage three circuits of sense cables; each one of these circuits has a maximum capacity of 40 sense cables (15 metres I total), or 120 lengths of sense cable, that is 1,800 metres maximum for an FG-NET unit. In addition to the presence of liquid, the system detects and locates any faults in cable breaks within the circuit.

The FG-NET Digital Unit is available in a rack-mounted (19" and 4U in height) version (FG-NET E), or a wall mounted version (FG-NET F).

The touch-screen on the front face makes the setup of the system easy: For example, you can nominate the zones for detection (by assigning a name to each sense cable), choose and configure the set-up (relays, serial links), set the system parameters (language, time adjustment, date, user access levels, relay setup, serial link connection, etc.).

The system's reaction time to faults on each sense cable is adjustable. It is possible to remotely isolate a sense cable for up to 72 hours. The Digital Unit can store up to 5000 events in the event log.

In order to explore the fault, three types of interface with a centralized technical management system are available: TCP/IP connection via an Ethernet port; JBUS/MODBUS protocol (Serial links - RS232, RS422/485 output) and nine relays: eight of which are fully configurable and one to interrupt the power supply.

This document is available on our web sites: www.ttkuk.com; www.ttkusa.com; www.ttk.fr; www.ttkasia.com; www.ttk.sg.

The information contained in this document is subject to modifications without notice. This information and diagrams have been drawn up carefully, however TTK UK Ltd., TTK Asia Ltd. or TTK S.A.S. cannot guarantee that the information provided does not contain any errors or omissions, and cannot accept any comparative responsibility for which the information is used. No part of this guide can be reproduced or transmitted without the express and written permission of the TTK UK Ltd., TTK Asia Ltd. or TTK S.A.S.

FG-NET and TOPSurveillance® are trademarks of TTK S.A.S.

TTK UK Limited

3 Luke Street
London EC2A 4PX
United Kingdom
Tel: +44 (0)207 729 6002
Fax: +44 (0)207 729 6003
www.ttkuk.com
sales@ttkuk.com

TTK Asia Limited

2108 Kai Tak Commercial Building
317 Des Voeux Road Central,
Hong Kong
Tel.: +(852) 2858 7128
Fax.: +(852) 2858 8428
www.ttkasia.com
info@ttkasia.com

TTK France S.A.S.

19, rue du Général Foy
75008 Paris
France
Tel. : +33 (0)1 56 76 90 10
Fax : +33 (0)1 55 90 62 15
www.ttk.fr
support@ttk.fr

CERTIFICATIONS

Electromagnetic compatibility E.M.C.

FG-NET E and FG-NET F fully conform to the requirements of generic harmonized European standards:



EN 61000-6-3:2007 for emissions

EN 61000-6-2:2005 for immunity

ATEX Certification

FG-ECS, FG-ACS and FG-OD can be used in explosive atmospheres when connected to the FG-NET panel.

TTK - Type: FG-OD
CE 0081  II 1G
Ex ia IIB T4 Ga
LCIE 13 ATEX 3082 X
IECEX LCIE 13.0072X

-30°C < T < +100°C

Equipment intended for use in explosive atmospheres, according to Directive 94/9/EC

Certification number: LCIE 05 ATEX 6065 X

International safety requirements

FG-NET E and FG-NET F are currently undergoing testing in order to conform to German and American safety requirements.







IEC 61010-1:2010

Conditions of Use

FG-NET shall be installed indoor only in environments meeting the Rated Pollution Degree 2 or better according to IEC 61010-1: Edition 3.

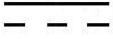
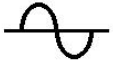
 This panel contains soldered, non-replaceable and not-serviceable lithium battery. Please dispose properly after removal, refer to the applicable laws in the country of installation and use!

Symbols used in this document and on FG-NET panel

	Direct current
	Alternating current
	Protective conductor terminal
	Caution, risk of electric shock
	Caution, risk of danger: please consult the current document where this symbol is marked on the panel
L	Live
N	Neutral

CHAPTER I: FG-NET DIGITAL UNIT INSTALLATION

1. MOUNTING THE FG-NET DIGITAL UNIT: E AND F

The FG-NET E Digital Unit is available in a rack mounted version (in a bay or a 19' casing).

It is advised to choose a location at eye-height level in order to facilitate reading the display.

The dimensions are as follows:

Width: 483 mm

Height: 177 mm

Depth: 74 mm

Weight: 3 kg



FG-NET (E) Rack mounted version

FG-NET F Digital Unit is also available in a wall-mounted version.

The dimensions are as follows:

Width: 228 mm

Height: 303 mm

Depth: 67 mm

Weight: 2.3 kg



FG-NET (F) Wall-mounted version

Open the cover of the wall-mounted Digital Unit in order to reach the motherboard which is fixed to the interior of the casing (as shown below):

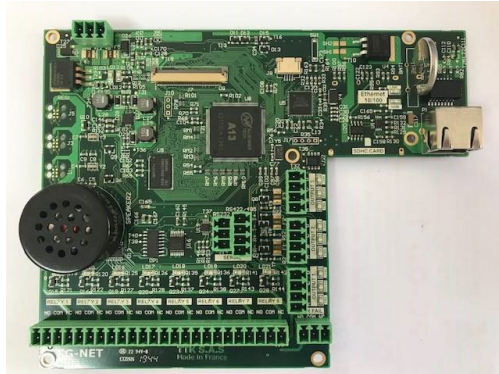
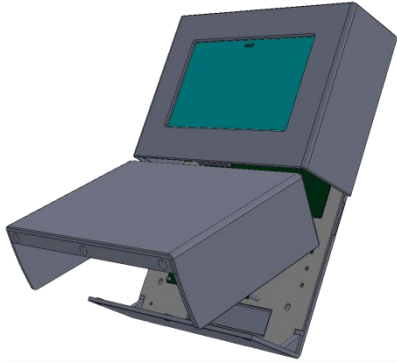

PLEASE DISCONNECT POWER PRIOR TO MOUNTING, OPENING OR CONNECTING THE PANEL TO ANY ELECTRIC CABLE.

2. ELECTRICAL CHARACTERISTICS

- Power Supply: 100-240V \sim , 50/60Hz (1).
- Power Consumption: 36 VA Max.
- Input Current Rating: 1.3 A
- Overvoltage Category: Class II
- Temperature Range: 0 – 40 °C
- Relative Humidity: 80% Max (2).
- Altitude Max.: 2000 m
- Ingress Protection Rating: IP40/NEMA1 – Indoor Use Only
- Sound level: Max. 70 dB @ 30 cm (buzzer annunciating an alarm)

(1) Mains supply voltage fluctuations not to exceed ± 10 percent of nominal voltage

(2) Maximum relative humidity 80 percent for temperatures up to 31°C decreasing linearly to 50 percent relative humidity at 40°C



A readily accessible disconnect device (of Live or Live + Neutral wires) shall be incorporated external to the equipment in the electrical cabinet powering the panel. The disconnect device shall meet the requirement of the relevant to the country of equipment installation standard. The nominal rating of the disconnect device is 2 A.

Dry contacts Characteristics:

Type:	1 RT
Max. switching voltage:	125 V \sim / 60 V ---
Max. switching current:	2 A
Max. switching power:	62,5 VA / 60 W
Working load min.:	5 V --- - 1 mA
Nominal load:	0,5 A at 125 V \sim 2 A at 30 V ---



Please note embedded relays are signal relays used for interfacing to BMS and other low-current signaling purposes. Do not use the dry contacts for direct connection to power loads as solenoid valves, etc.

Sensing Cables Outputs:

- Rating: 12 V ---
- Nominal Voltages on the sense cable circuit (all voltages referred to Ground):
 - 1A, 2A, 3A, 1B, 2B, 3B: 5 V ---
 - 1D, 2D, 3D: 12 V ---
 - 1C, 2C, 3C: 0 V (electrically connected to Ground)



Please use only FG-EC, FG-AC sensing cables supplied by TTK or authorized distributors!

3. ELECTRICAL CONNECTION OF THE FG-NET DIGITAL UNIT

All connections are made on the Digital Unit's motherboard. The connector blocks are directly accessible and removable on the FG-NET E; for the FG-NET F however (the metal wall mounted version), it is necessary to remove the three screws on the lower section to open the front panel.

See Appendix no.1: 'FG-NET E / F Digital Unit Connection' at the end of this guide.

3.1. Connecting the FG-NET Digital Unit to the earth



Respect the rules for Electromagnetic Compliance and Electrical Safety:

It is absolutely necessary to connect the Protective Ground (PE) to the AC Power terminal connector!

The use of the cable tie to hold together the three wires of the power supply is compulsory!



3.2. Connecting the power supply cable



Prior to connecting the power, please ensure the mains cord is disconnected from any source of electrical energy!

A flexible mains cord H05VV-F 3 x 1.0mm² or H07VV-F 3 x 1.5 mm² meeting the requirements of the country where equipment is installed*, not provided by TTK, shall be used for the connecting the AC power supply of FG-NET. The power supply is connected to fixed 3-points terminal block on backplane of the panel. Respect the colour identification code:

Brown – Live

Blue – Neutral

Yellow/Green – Protective Earth

The mains cord is entering the bottom of the panel enclosure by cable gland PG-11. Please ensure the gland is turned tight on the cable and there is no excessive pull force on the cord inside and outside the enclosure. Excessive pull force on the power cord may lead to losing the power supply from terminal block!

Please use the following procedure to prepare and connect the power supply cord:

1. Carefully strip the overall jacket and the individual wire insulation of flexible cord H05VV or H07VV as shown on the picture below. The yellow/green wire shall be left abt 10 mm longer than brown and blue:

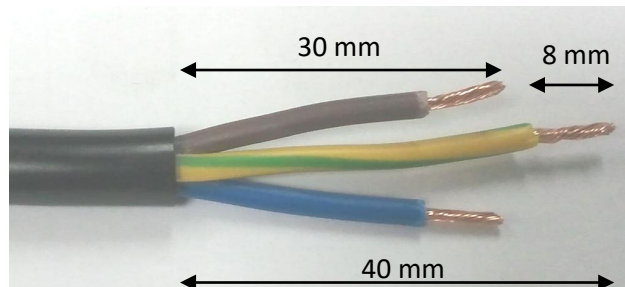

2. Introduce power cord into cable gland on bottom on the panel and connect the stripped cord wires to the terminal block as follows – brown to L, yellow/green to PE and blue to N:

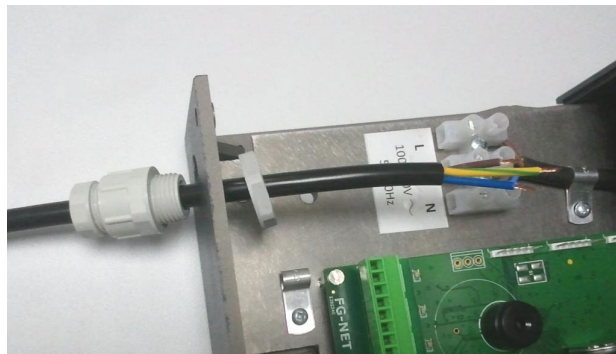

****For Europe, the mains cord shall meet the requirements of IEC 60227 or IEC 60245. For USA and Canada, the mains cord shall meet the requirements of ANSI/UL 817 and CSA C22.2 No.21. For other countries, please refer to relevant standard.***

3. Fix tightly together the three wires of the power cord at the terminal block with the supplied cable tie as shown on the picture. Cut the free length of the cable tie and fix the cable gland on the panel bottom and on the cable – the power cord shall be slightly loose inside the enclosure:

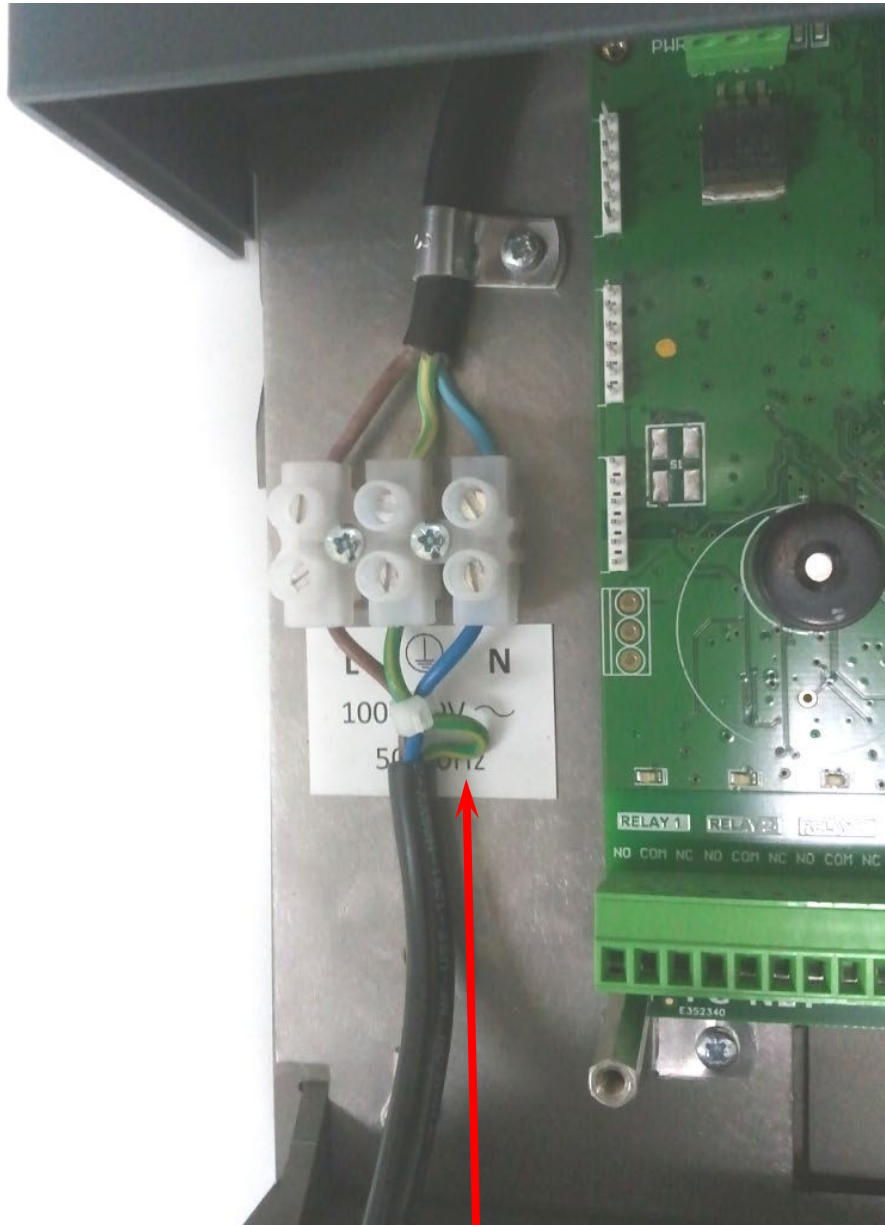

Please note the extra length of the grounding wire!

(See also Appendix n°1: FG-NET Digital Unit Electrical Connections)



When the unit is used in a way not specified by the manufacturer, the protection guaranteed by the device can be compromised.

IF THE DEVICE IS PERMANENTLY IN USE an interrupter or circuit breaker must be used.

If there is no interrupter included with the unit:

- An interrupter or circuit breaker from the site's electricians should be put into use.
- It should be in close proximity to the unit and within easy access of the OPERATOR.
- It should be marked as the unit's disconnecting and earthing device.

3.3. Connecting the leader cable FG-CLC

(See Appendix no. 1)

Each circuit of sense cables (1, 2 or 3) is connected to the FG-NET Digital Unit with a TTK leader cable (TTK BUS 8723), ref. FG-CLC



An inversion between the two couples red + black, and green + white can damage the electronics of the first connected sense cable.

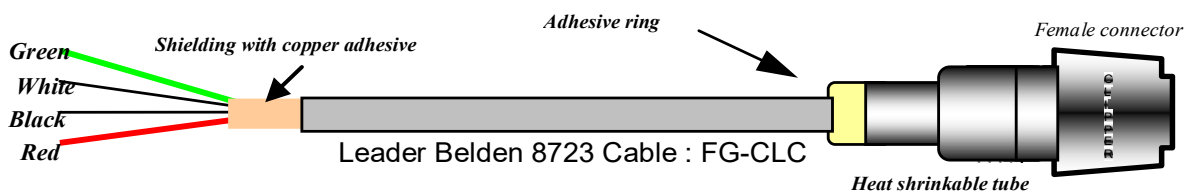

Three circuits are available; use circuit no.1 initially, then the following circuits (if necessary).

Each circuit has a maximum capacity of 40 sense cables.

When circuit no.2 is used:

- Remove the existing shunt between 2A and 2B.

When circuit no.3 is used:

- Remove the existing shunt between 3A and 3B.



To avoid electromagnetic disturbances and emissions (ECM), it is necessary to connect the shielding of the leader cable to the earth. Fix the shielding of the leader cable using a metal cable clamp (available inside the casing).

(See Appendix: Digital Unit Connection: FG-NET E / FG-NET F)

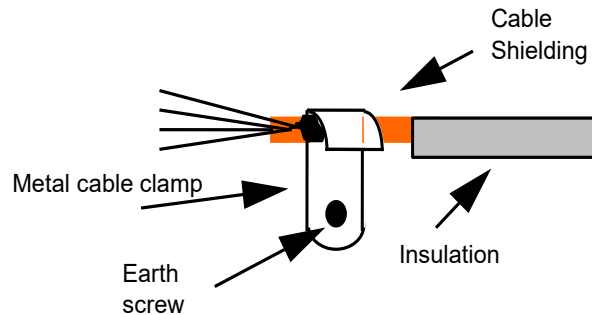

3.4. Connecting the internal relays

Nine internal relays are available on the FG-NET Digital Unit with connector blocks. The electric characteristics of these relays are as follows:

Type:	1 RT
Max. Switching Voltage:	125 V \sim / 30 V ---
Max. Switching Current:	2 A
Max. Switching Power:	62.5 VA / 60 W
Working load min.:	5 V --- / 1 mA
Nominal load:	0.5 A to 125 V \sim 2 A to 30 V ---

You can configure each of the relays in the 'CABLES' MENU.

Relay configurations are as follows:

- Fault type: Leak or cable break, leak and cable break, OFF.

For each sense cable, the user can create a list of relays to be activated on leaks, or cablebreaks, or both of them. It's possible to use the internal relays, and/or external relays when using a FG-RELAYS additional device providing up to 24 relays per box (max 16 boxes) for a total of 393 relays.

3.5. Connecting the serial cable

The serial cable is used as an exit towards a JBUS/MODBUS communication in RS232 or RS422/485. It is connected to a SERIAL connector (see Appendix: Digital unit connection: FG-NET E / FG-NET F).

The 4-point connector is used for the RS422/485 and the 3-point connector for the RS232. Please note that the simultaneous use of RS232 and RS422/485 is impossible.

3.6. Closing the FG-NET F Digital Unit

Once all connections have been finished, close the FG-NET F Digital Unit (as shown below):

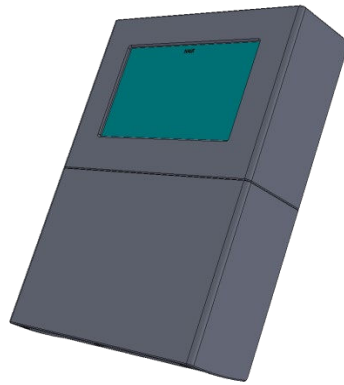

For the rack version (FG-NET E), we recommend fixing the various cables carefully to the 19' bay, using a comb (for example).

CHAPTER II: CABLE AND ACCESSORIES INSTALLATION

The FG-NET system is modular. All the sense cables and accessories are pre-terminated with both male and female connectors. This makes the installation quick, easy, and safe.

We recommend drawing a precise map of all zones to be fitted with sense cables, ensuring that all installation zones are clean and dry before installation.

1. INSTALLING ADDRESSABLE SENSE CABLES

1.1. Hold-down adhesive clips

The sense cables are fixed to the earth with adhesive clips, type CF-EC100. (100 clips available per tube of adhesive).

The first stage of the installation consists of sticking these clips to the earth using the adhesive provided.

Recommendations:

1. To ensure the cable sticks correctly to the earth, alternate the direction of the clips on the earth.
2. The clips must follow the drawing of the sense cables and be spaced approximately 1 metre apart.
3. Wherever there is a curve of the trajectory, stick 1 clip the entry point and a second at the exit point of curve.
4. Please wait for the clips to be completely dry (three to four hours), before installing the sense cables.
5. When fixing the sense cables into the clips, keep a length of approximately 10 cm between the connector and the clip.

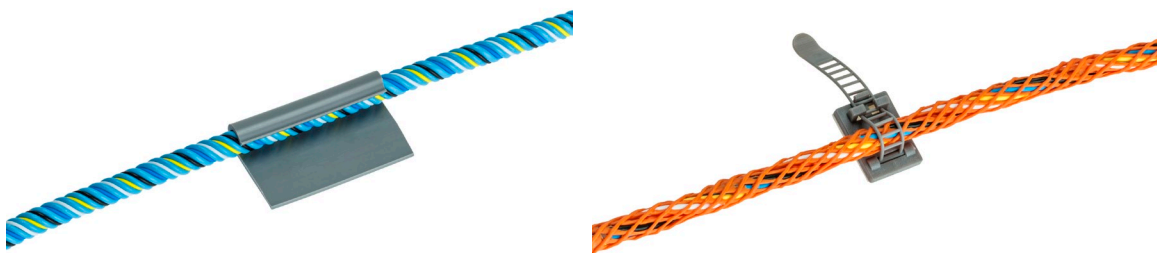

Hold-down adhesive clips on a section of the sense cable (product ref. CF-EC100; CF-OD50)

1.2. Installing sense cables: FG-EC, FG-AC and FG-ECX

Unroll the entire length of the sense cable and place in the clips fixed on the floor before installation.

Caution!

Pay attention to the direction of the sense cables!

The FG-CLC leader cable is connected to the FG-NET Digital Unit. The sense cable starts with a male connector, and ends with a female connector. On board electronics are located at the end of the sense cable.

1. Connect the first sense cable to the leader cable (coming from the FG-NET Digital Unit).
2. It is recommended that you avoid placing the cables in direct contact with the jacks (on the raised floor), the cable trays, any other obstacles...
3. Take care to circumvent the air-conditioning system (at a distance of approximately 50 to 75 cm), to avoid false leak alarms related to harmless water projections.
4. All partitions must be fitted with pre-determined neutral TTK BUS 8723 cables: type FG-NC (1 or 3 metres).
5. Once the sense cables are fixed with clips, their length must be maintained along the flooring or ceiling in a closed retention tray, etc...
6. ES-40 tags must be placed along the length (packet of 40 tags) and spaced approximately every 4 metres.
7. Place a new length of sense cable (a pre-terminated neutral TTK BUS 8723 cable and finish the circuit with a modular end termination plug.

1.3. Installing hydrocarbon and solvent sense cables: FG-OD

DESCRIPTION

The Oil&Gas FG-OD detection cable from TTK allows for the fast detection of any leaks of hydrocarbon liquids. The presence of a real liquid leak, hydrocarbon or solvent, activates an audible alarm, and detailed information is displayed on the Digital Unit with the hour, date, and type of fault: leak or cable break. The dry contact related to the fault switches to the alarm position. This dry contact makes it possible to drive an external alarm and be reported to a management team via BMS, remote monitoring, solenoid valve, etc...

The dry contact remains activated as long as the alarm is present. Once the alarm has been cleared, the relay returns to its initial position.

Due to ATEX regulations, FG-OD cables are using a different communication protocol, and they must be connected to the system through a bus interface box FG-DOD. Up to 10x FG-OD cables can be connected to one FG-DOD box.

The FG-OD kit contains:

1. A OD bus interface box for up to 10x FG-OD (FG-DOD)
2. A length of FG-OD sense cable (3, 7 or 12m)
3. A OD leader cable (FG-CLOD)
4. A OD end termination plug (FG-TMOD)
5. Hold-down adhesive clips (CF-OD50)
6. FG-OD kit installation instructions

Caution!

All FG-OD hydrocarbon or solvent sense cables must be installed in clean areas.

Connection with a FG-NET Digital Unit:

The set contains:

1. FG-NET Digital Unit
2. One or more Digital FG-OD kits for FG-NET (up to 40x FG-OD cables per circuit)
3. One or more additional FG-OD sense cables (max 10 FG-OD per FG-DOD)

To connect the FG-NET Digital Unit, follow the FG-NET installation instructions guide in chapter 1.3 of this document.

FG-NET has a capacity of 40x FG-OD cables per circuit. Those cables must be connected to the panel through a FG-DOD bus interface by groups of ten cables maximum.

Example: 4x FG-DOD with 10x FG-OD cables each = 40x FG-OD

Or: 8x FG-DOD with 5x FG-OD cables each = 40x FG-OD

Or: 2x FG-DOD with 10x FG-OD cables each + 4x FG-DOD with 5x FG-OD cables each = 40x FG-OD

The FG-NET power supply must be switched off.

1. Connect the TTK BUS 8723 cable to circuits 1, 2 or 3 in the FG-NET Digital Unit:

On circuit no.1:

Green wire: Point 1A

White wire: Point 1B

Black wire: Point 1C

Red wire: Point 1D

2. Connect the other end of the TTK BUS 8723 jumper cable to the INPUT points of the first FG-DOD interface box.
3. Take the FG-CLOD 3.5 m leader cable and connect it to the following points of the 'OD BUS' terminal of the first FG-DOD interface box:

White wire: Point B

Black wire: Point C

Red wire: Point D

4. Fix the provided hold-down clips (1 clip per meter) and place the FG-OD sense cable in the clips.
5. Connect the FG-OD cable to the FG-CLOD leader cable, then add a second, third... FG-OD cable (10x max) and put the FG-TMOD end plug at the end of the last FG-OD cable.
6. 7. Pour some light Naphta on the cable to simulate a leak alarm.
7. 'OUTPUT' is reserved for the neutral cable going towards the next detection zones.
8. Proceed as with stage 2 for the second (and third etc.) FG-OD kits.
9. **Note:** on the last FG-DOD box, a bridge must be installed on the unused 'OUTPUT' terminal between points A and B.

OPERATION AND MAINTENANCE

The FG-OD sense cable is insensitive to the limited presence of conducting liquids (water, bases or acids); FG-OD is also insensitive to any residual traces (lower than 35 ml) of non-conducting liquids (hydrocarbons or solvents). The sense cable absorbs this limited presence of liquid and does not react.

In the presence of a quantity (at least equal to 50 ml) of non-conducting liquids (hydrocarbons or solvents), the FG-OD sense cable activates an alarm on the Digital Unit.

FG-OD cables are reusable after a limited contact with hydrocarbons. Immerse the cable in light Naphta during 30 minutes, then remove and allow drying for few hours.

Caution!

All hydrocarbon sense cables must be installed in clean areas.

1.4. Labelling with tags

ES-EC and ES-OD tags indicate the presence of installed sense cables. Part of the label is intended for the user to note the distances during water leak simulations.

- Fix the tags every five metres on the sense cable circuit.
- Ensure the tags are clearly visible.

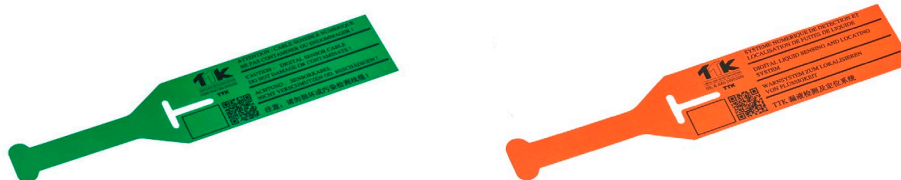

Pack of 40 Tags, ref.: ES-EC (for water and acid sense cables); ES-OD (for oil sense cables)

2. INSTALLING FG-NC JUMPER CABLES

It can be necessary to use jumper cable to:

- Pass from one detection zone to another
- Connect the Digital Unit to the first detection zone
- Pass through any partitions...

Note:

To pass through partitions, the sense cable must be adapted with a product that suits any regulations and / or the on-site architecture (partition wall, fireproofed walls etc.).

In order for the system to operate correctly, the following jumper cable should be used:

TTK BUS 8723 (LSZH, if required)

This jumper cable must be equipped with a male and female connector in order to be compatible with TTK sense cables. The FG-NC kit includes the following material for this purpose:

- A male CLIPPER with its 4 contacts
- A female CLIPPER with its 4 contacts
- 2 heat-shrinkable sleeves (45 mm in retractable thermal heat gain (restraint: 24/6)
- 2 hot melt glue rings
- 1 jumper cable instructions

Tools required:

- Stripping pliers
- 800 w heat gun
- Flat-nose pliers

Jumper cable connection

The FG-CLC jumper cable is installed. The beginning of the jumper cable is at the end and coming from the Digital Unit. Always start by making the connection at the beginning of the cable. The beginning of each cable must be provided with a male connector and the end of the jumper cable with a female connector.

At the beginning of the TTK BUS 8723:



- Strip the external sheath by 20mm.
- Strip the 4 wires by 5mm.
- Do not cut the shielding wire.



- Crimp a male contact on each of the four wires. The shielding wire is to be crimped in the same contact as the black wire.

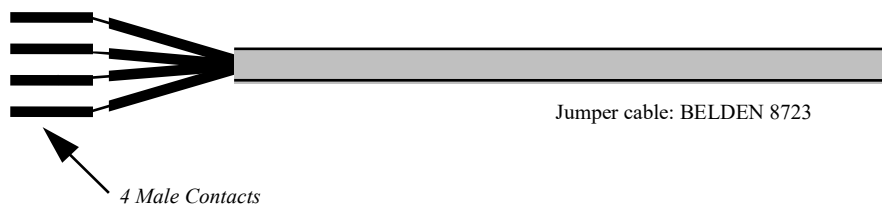

- Slide a 45 mm heat shrinkable tube onto the jumper cable.

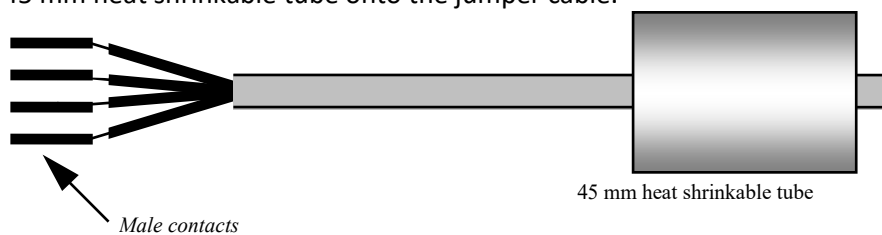

- Do not cut the shielding wire. Prepare the male connector (the longest).
- Encase the 4 contacts in the connector, pull the red plate while pressing on the sides (it should not be entirely removed. This is normal).

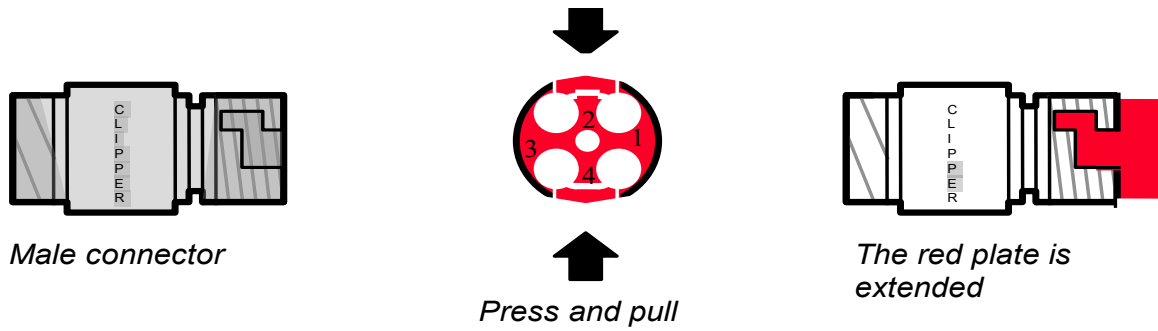

Insert the four contacts then using the following code:

- | | |
|--------------------------------|-------------------------------------|
| Red wire: | point no.1 of Male Connector |
| Black wire + shielding: | point no.2 of Male Connector |
| White wire: | point no.3 of Male Connector |
| Green wire: | point no.4 of Male Connector |

And then, return the red plate to its original position by pressing on the sides.

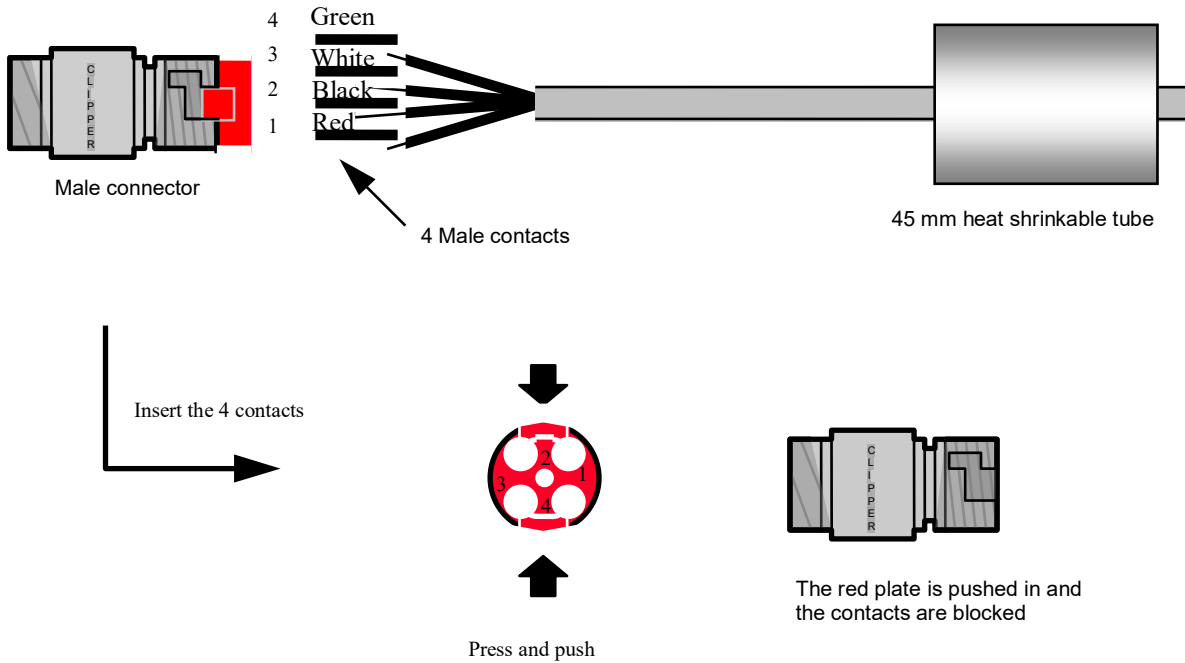

The wires are now blocked.

This process makes it possible to easily remove at a later date if necessary.

Caution!

If the contacts are not entirely inserted into the connector, the red plate will not go back into the connector.

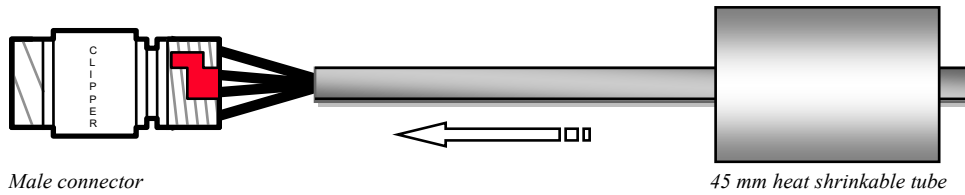

- Cover the connections and screw with the heat shrinkable tube (which should already have been slipped onto the cable).
- Place an adhesive ring (a circle of glue) at the rear of the tube, on the cable side.

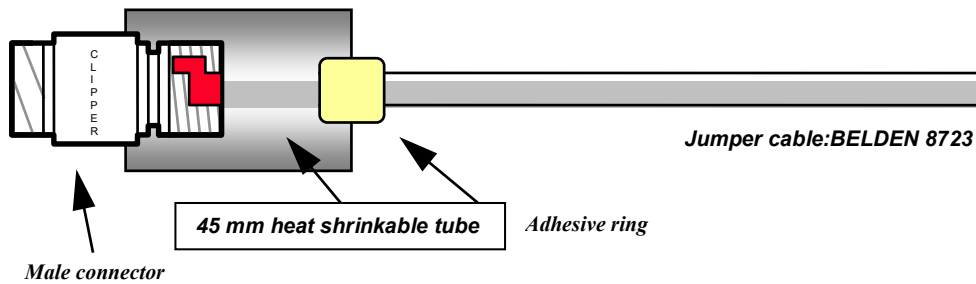

- Heat the whole cable with a heat gun to shrink the tube. Heat it on the side of the male connector whilst holding it down so that it remains in place. Then heat the whole of the heat shrinkable tube.
- Heat it sufficiently to melt the adhesive ring until the adhesive is visible outside the tube (on the cable side).

Caution!

Do not heat it too much, or you risk the cable overheating and melting.

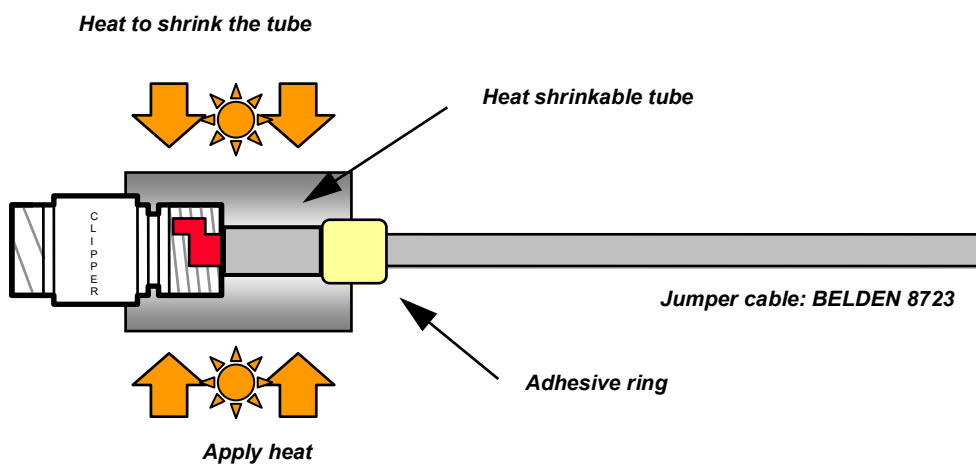

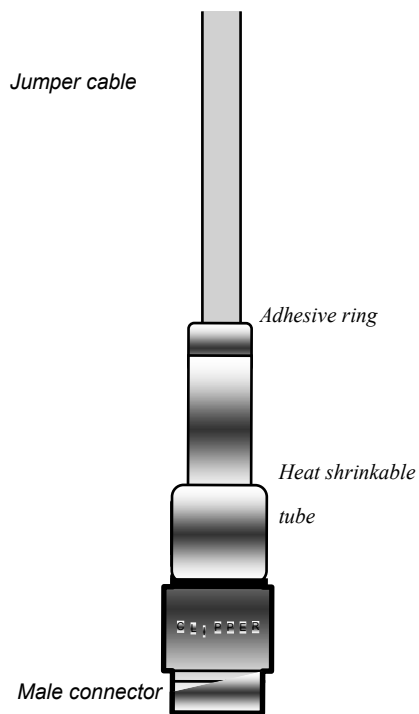

- Leave the tube cool down in a vertical position, with the connector facing downwards.

Proceed in the same way for the other end with a female connector and female contacts.

DO NOT CONNECT THE SHIELDING WIRE!

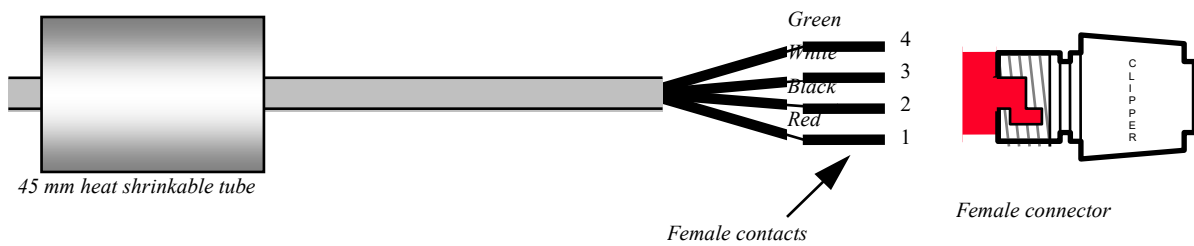

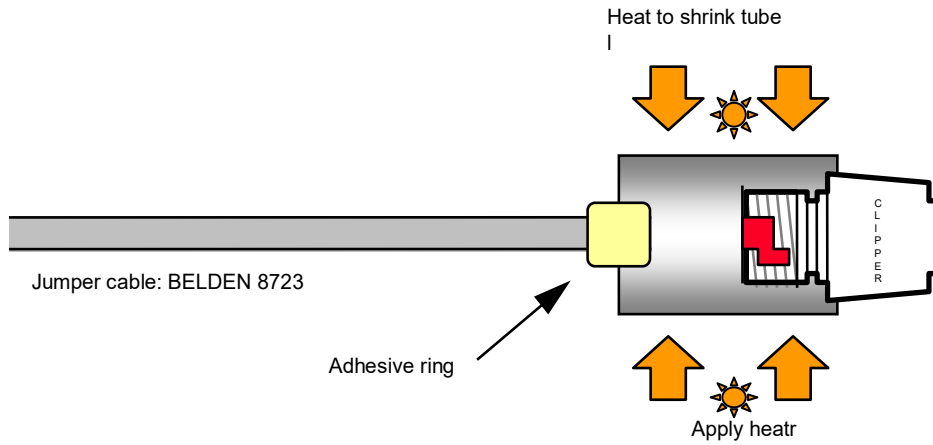
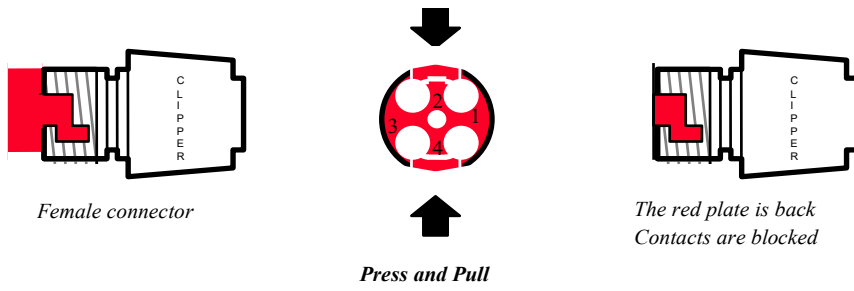

The completed jumper cable is as follows:

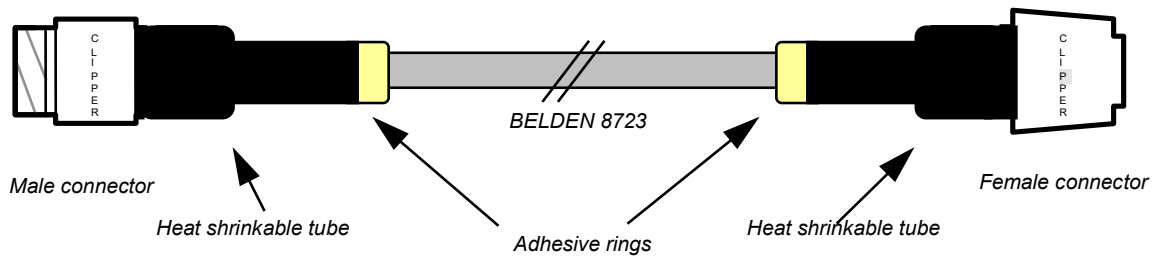

3. INSTALLING CONNECTION ACCESSORIES

3.1. FG-DTM - Modbus Interface

FG-DTM is a Modbus interface, designed to merge the product line of digital and analogue systems. It collects information from analogue panels and integrates them into the digital system. Therefore, the digital panel acts as central monitoring unit on which analogue panels and all connected sense cables circuits can be supervised. Meanwhile, each analogue panel acts as an independent local detection module.

In the event of a leak being detected on a local panel, it sounds an alarm, activates local relays, displays the location on the module and simultaneously sends signals to the digital panel, where all circuits are monitored. As a result, alarms are displayed at the same time on both the local panel and central monitoring panel. When the BMS is configured, all alarms will also be reported on this.

- FG-DTM can monitor up to 60 meters of sense cables on each analogue circuit of the FG-ALS8 panel; and up to 45 meters for the FG-ALS4 panel.
- Up to 10 FG-DTM boxes can be connected on a FG-NET / FG-SYS / FG-BBOX circuit.
- Up to 30 meters of distance of the RS485 line between a FG-DTM box and an analogue panel.

The connection diagram is located on the addressable box packaging. (See below for details)



Caution!

In the last FG-DTM, the circuit must be completed with a shunt in the OUTPUT of the circuit board (between A and B).

The INPUT is linked to the **TTK BUS 8723 cable coming from the FG-NET Digital Unit**, or from the last FG-DTM box

The OUTPUT is linked to the TTK BUS 8723 cable leaving towards **the next box**

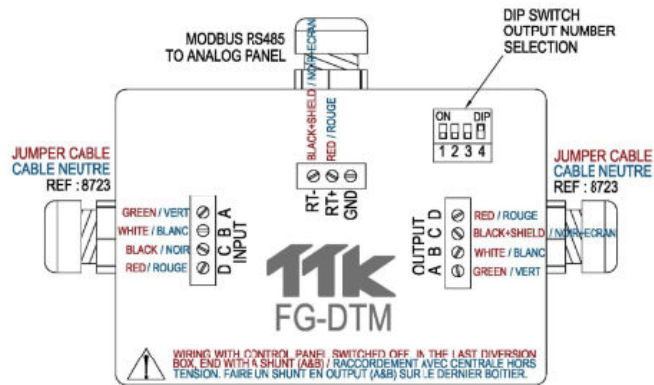

The LED on the lid of the box indicates the box's status in real time:

- Green blinking: correct response from the Modbus slave (analogue control panel);
- Red blinking: no response from the Modbus slave (analogue control panel).

Connection Schematic:

Wires connection on FG-DTM box.

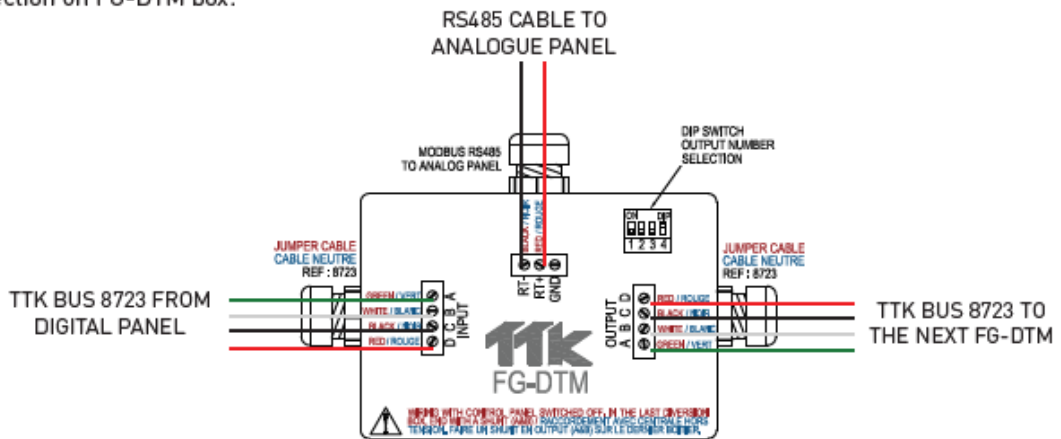

Wires connection and loop on the last FG-DTM box on a circuit.

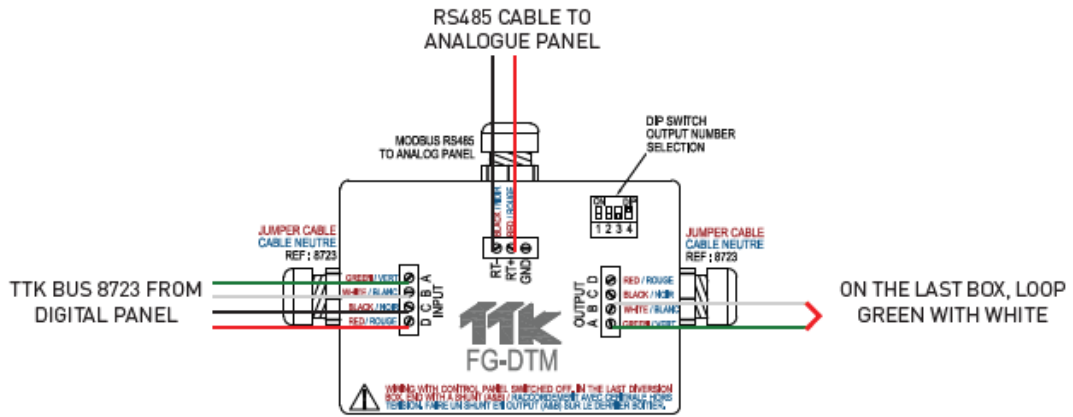

Basic integration of one analogue detection panel FG-ALS8 and analogue sense cables into a circuit of FG-NET digital panel:

DigitalPanel FG-NET Features:

- 8 configurable Relays
- 1 power Fail Relay
- 1 Ethernet Port (TCP/IP)
 - ↳ Modbus TCP/Emails/SNMP Traps
 - ↳ Web Interface
- 1 Serial Port
 - ↳ RS232/RS422/RS485
 - ↳ Modbus RTU

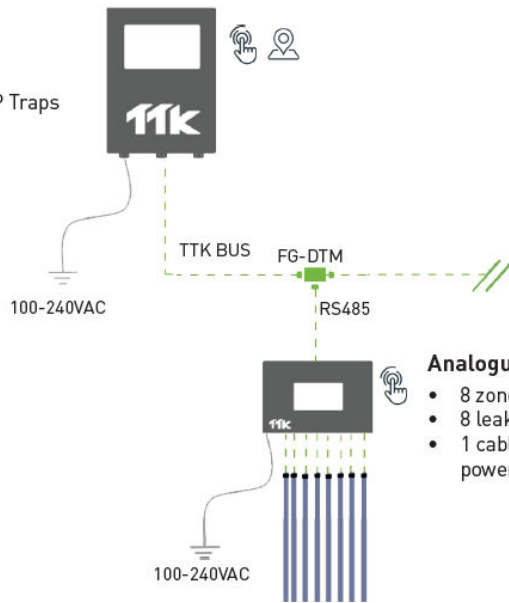

Analogue Panel FG-ALS8 Features:

- 8 zones (up to 60 meters)
- 8 leak relays
- 1 cable break relay (common) + power fail relay

For the DIP Switch configuration, ref this Excel sheet (and go to the last sheet “FG-DTM Dip Switch Configurator”):

https://www.ttk.fr/wp-content/uploads/2021/01/TTK-Modbus-registers-calculator_012021.xlsx

You can also visit this webpage and download “TTK Modbus Registers Calculator”:

<https://www.ttkuk.com/water-acids-leak-detection/documents/modbus-communication/>

3.2.FG-DTCS - Addressable Box

The FG-DTCS addressable box allows the connection of the FG-ECS sense cable to the main bus wire; this box is provided with three holes with cable glands: 'INPUT', 'OUTPUT' and 'FG-ECS'.

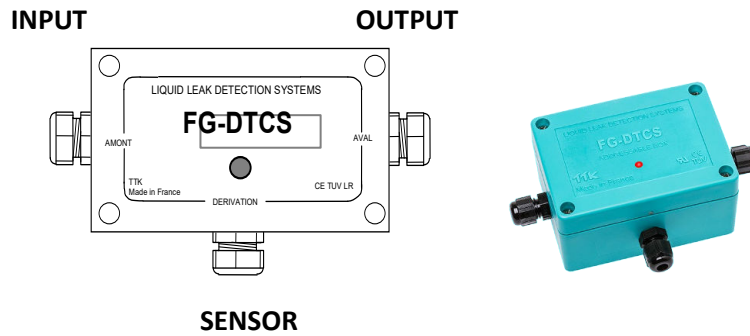

The connection diagram is located on the addressable box packaging. (See below for details)

Caution!

In the last sector addressable box, the circuit must be completed with a shunt in the OUTPUT of the circuit board (between A and B).

The INPUT is linked to the **TTK BUS 8723** cable coming from the **FG-NET Digital Unit**, or from the last FG-DTCS addressable box

The OUTPUT is linked to the TTK BUS 8723 cable leaving towards **the next addressable box**

The FG-ECS / FG-ACS exit is linked to the **FG-ECS or FG-ACS** sense cable.

The LED on the front face of the box indicates the box's status in real time:

- Blinking green: normal, no alarm.
- Blinking red: leak detected on the box.
- No LED light: cable break detected on the box or loss of communication.

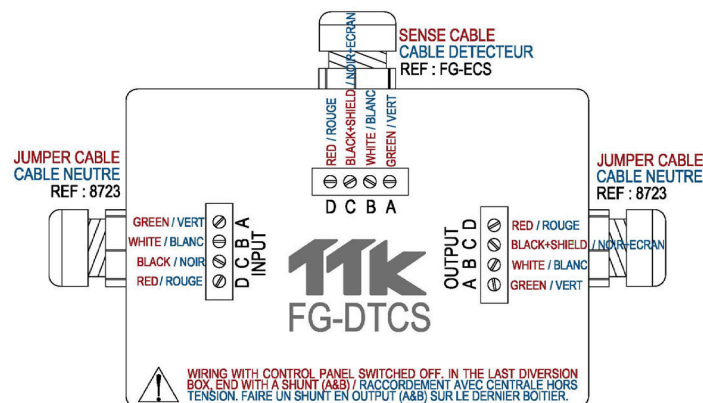

3.3. FG-DCTL – “Cut-to-Length” Addressable Box

The FG-DCTL “Cut-to-Length” addressable box allows the connection of custom lengths (from 1 to 45 meters) of FG-ECS, FG-ACS, FG-ECX and FG-ACX sense cable to the main bus wire; this box is provided with three holes with cable glands: 'INPUT', 'OUTPUT' and 'SENSOR'.

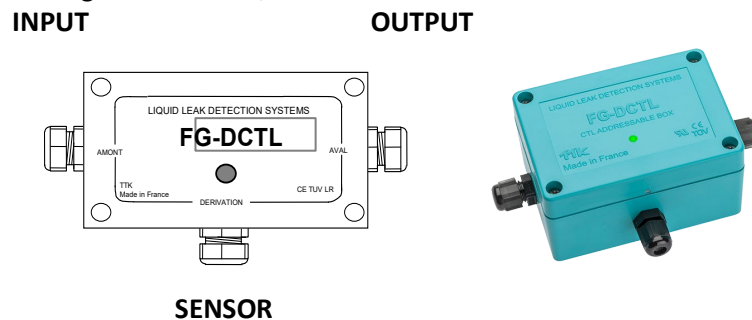

The connection diagram is located on the addressable box packaging. (See below for details)

Caution!

In the last FG-DCTL addressable box, the circuit must be completed with a shunt in the OUTPUT of the circuit board (between A and B).

The INPUT is linked to the **TTK BUS 8723 cable coming from the FG-NET Digital Unit**, or from the previous FG-DCTL addressable box

The OUTPUT is linked to the TTK BUS 8723 cable leaving towards **the next FG-DCTL addressable box**.

The SENSOR output is linked to the **FG-ECS, FG-ACS, FG-ECX or FG-ACX sense cable**.

Up to 30 FG-DCTL boxes can be installed on one circuit, with a maximum of 70 FG-DCTL boxes on one panel.

The LED on the front face of the box indicates the box’s status in real time:

- Blinking green: normal, no alarm.
- Blinking red: leak detected on the box.
- No LED light: cable break detected on the box or loss of communication.

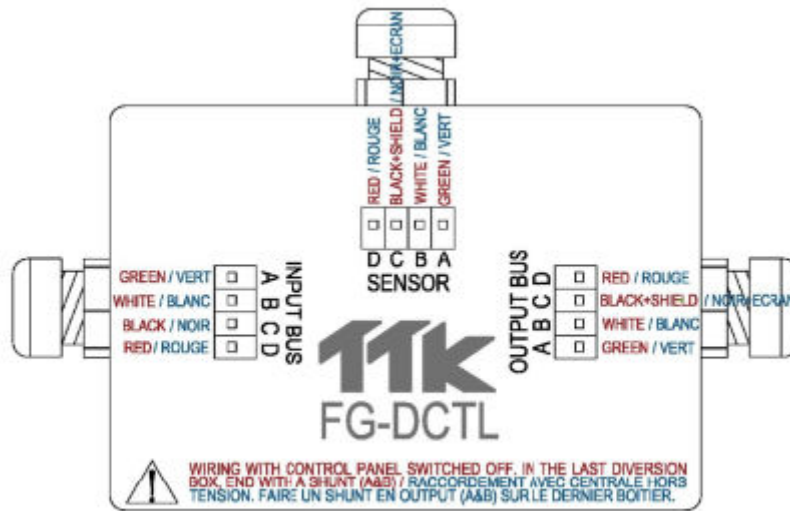

3.4. FG-DTC - TTK Bus Diversion

The TTK Bus Diversion box makes it possible to break up a detection circuit into two parts. The box is provided with three cable glands: 'INPUT', 'OUTPUT2' and "OUTPUT1'.

Diagram:

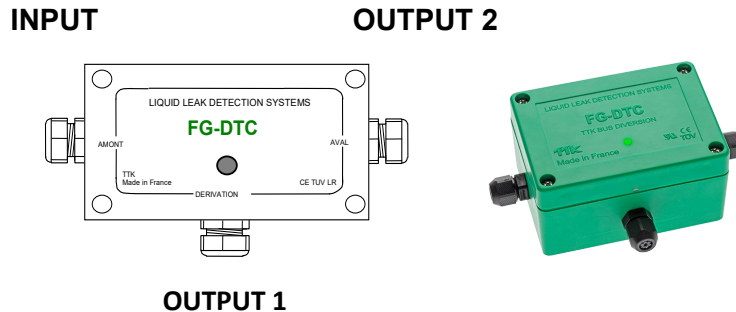

The connection diagram is located on the box packaging.

See below for instructions on how to connect the FG-EC or FG-AC cables to the main bus wire, or to connect the sense cables to each other.

The INPUT is linked to **the TTK BUS 8723 cable coming from the FG-NET Digital Unit**, or from the last FG-DTCS diversion box

OUTPUT1 is linked to the FG-EC or FG-AC **sense cables**.

OUTPUT2 corresponds to the **TTK BUS 8723 cable at the end of the circuit**.

The LED on the front face of the box indicates the box's status in real time:

- Blinking short blue followed by a long green: normal, no alarm.
- Blinking short blue only: cable break detected on the box.
- No LED light: loss of communication.

Caution!

When an output is not being used (for example OUTPUT 2 in the last diversion box), a shunt is needed between A and B.

Caution!

Installation of the FG-DTC diversion box must **ONLY** be performed when the FG-NET Digital Unit is switched off.

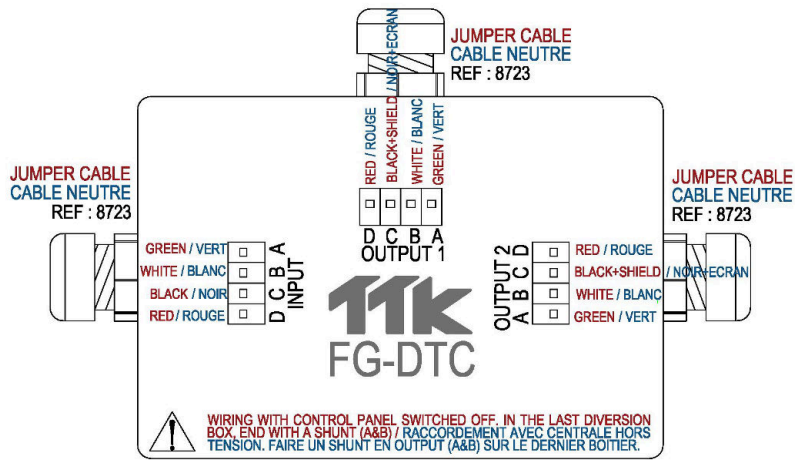

3.5. FG-DOD - OD Bus Interface

The OD Bus Interface box makes it possible to integrate FG-OD cables on a standard TTK Bus installation with water/acid sensors. The box is provided with three cable glands: 'INPUT', 'OD BUS' and 'OUTPUT'.

Diagram:

INPUT

OUTPUT

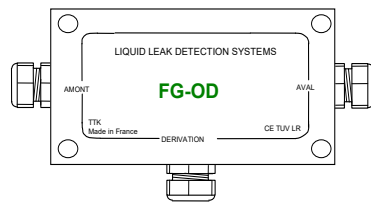

OD BUS

The connection diagram is located on the box packaging.

See below for instructions on how to connect the FG-OD cables to the main bus wire.

The INPUT is linked to **the TTK BUS 8723 cable coming from the FG-NET Digital Unit**, or from a previous box

OD BUS is linked to the **FG-OD sense cables** (10 x max per FG-DOD box)

OUTPUT corresponds to the **TTK BUS 8723 cable towards the end of the circuit.**

Caution!

When an output is not being used (for example OUTPUT on the last box), a shunt is needed between A and B.

Caution!

Installation of the FG-DOD Interface box must **ONLY** be performed when the FG-NET Digital Unit is switched off.

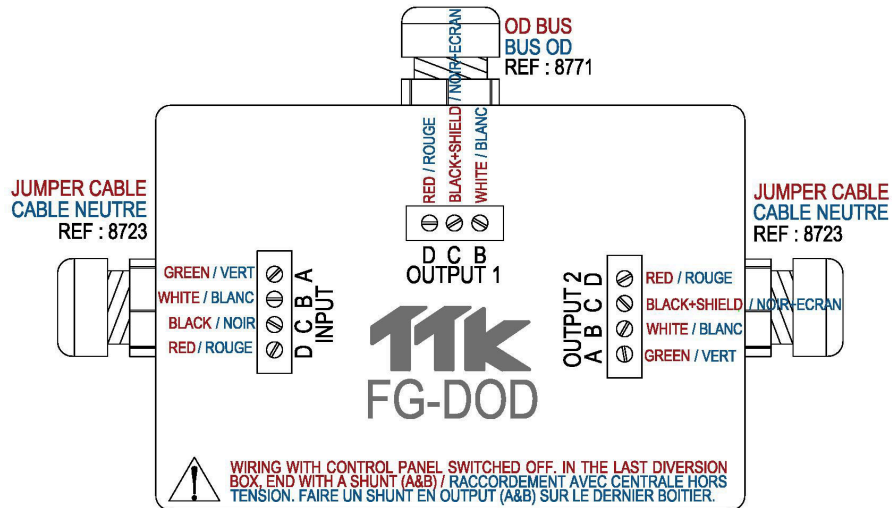

3.6. Installing end termination plugs

(ONLY use with FG-EC, or FG-AC sense cables and Digital Units FG-NET, FG-SYS)

Each circuit of sense cable must end at an OUTPUT with an end termination plug; a male connector is used for circuit continuity.

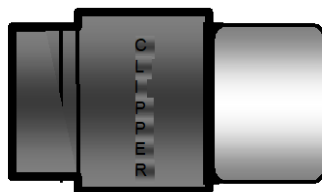

Modular end termination plug: FG-TMC

CHAPTER III: DIGITAL UNIT STARTUP



In case the equipment is used in a manner not specified by the manufacturer, the protection against hazards provided by the panel could be compromised!!!

1. FG-NET DIGITAL UNIT – POWERING ON

When all of the cables (leader cables, jumper cables, sense cables, power supply cables) and accessories (diversion boxes, end termination plug) are connected, switch the FG-NET Digital Unit ON.

Once the Digital Unit is turned on, an image indicating the operating system's downloading status will be shown on the touch screen display (see below):

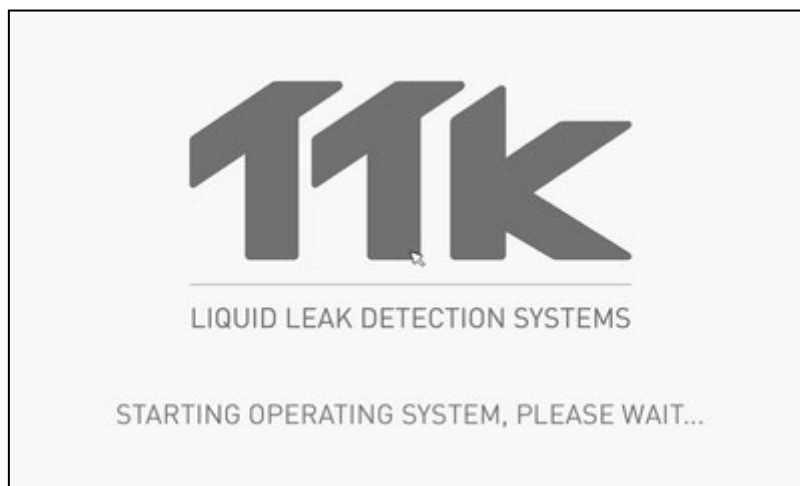

After the operating system has finished downloading, the home page appears with an alert stating a change in the sense cables' architecture. Click on OK to remove the alert.

[See chapter III, Paragraph 2.3.2 – Automatic control of the architecture system.](#)

Four menus represented by icons are accessible. The date and the time are indicated on the bottom right-hand side.



2. MENUS

Four menus on the home page are accessible: 'Setup', 'Event log', 'Cables', and 'Help'. These menus enable the user to configure the Digital Unit and obtain various pieces of information on installation procedures.

2.1. Setup

Only the administrator can access the menus and configure or modify the system's settings. The administrator can access the 'Users' and 'Communications' tabs.

1. Admin (1 admin) - full access, including 'Setup'
2. Users (max. 5 users), configurable access rights (everything except 'Setup')
3. Free access, configurable access rights (everything except 'Setup')

There is no override password. Leave this field blank.

If the Admin loses their password, please contact TTK who will provide you with another valid password within 24 hours.

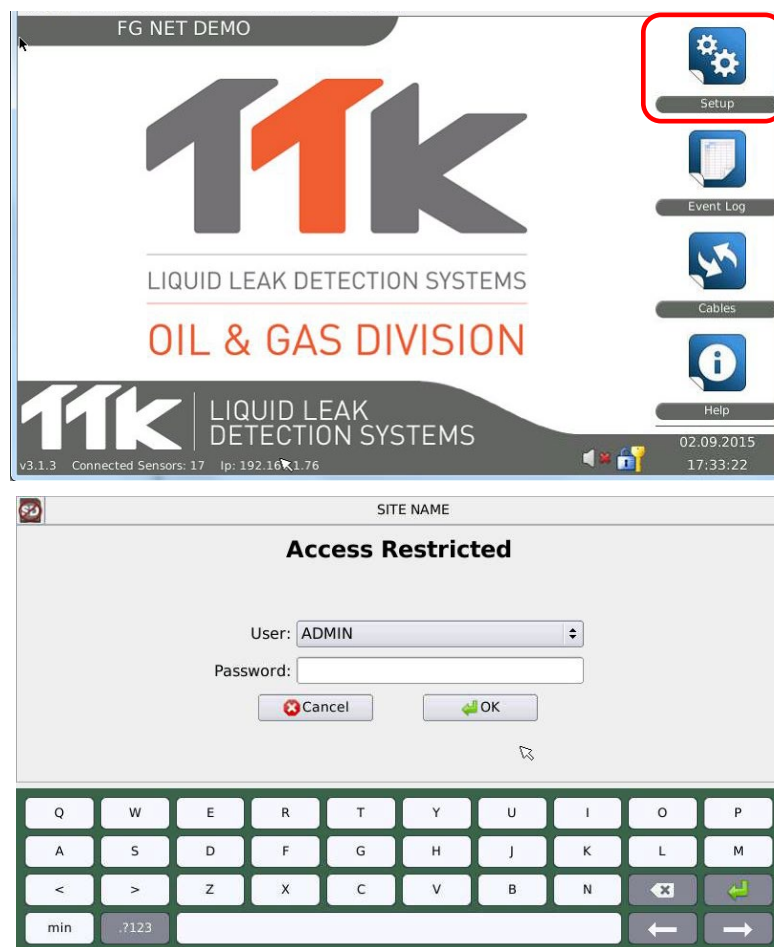

2.1.1 'System' tab

Home → Setup → System (1/2)

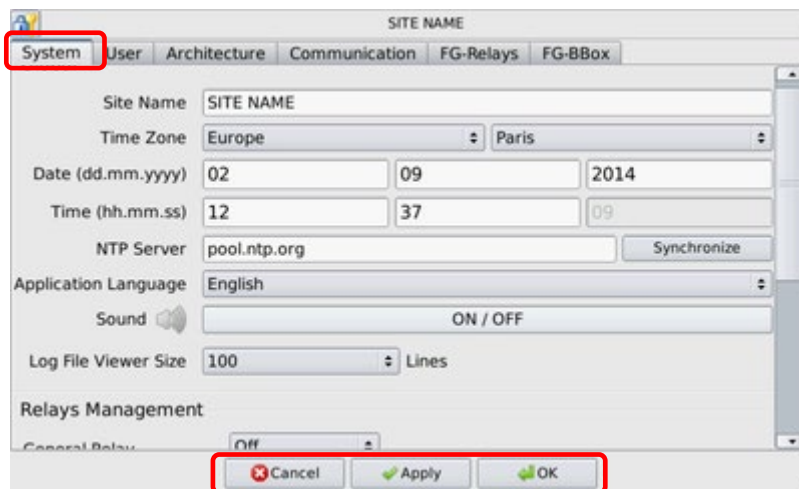

After all modifications are complete, the user can choose 'Cancel', 'Apply', or 'Validate'.

- Cancel: Leave the menu without saving modifications.
- Apply: Save modifications without leaving the menu.
- Validate: Save modifications and leave the menu

Home → Setup → System (2/2)

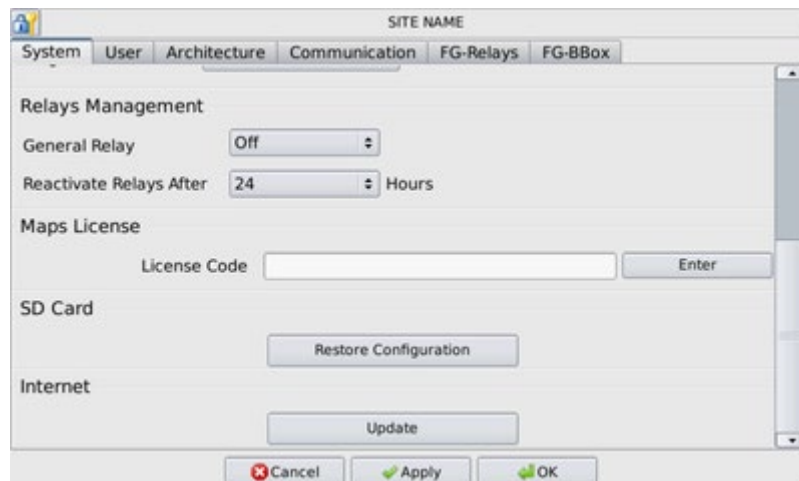

The 'system' tab enables the user to define several items on the Digital Unit: the site name, the time zone, the date, the time, the NTP server, the system language, the sound, the number of events in the event history, relay reactivation, map unlocking, the SD card restore option, and Internet updates.

- Site name: The user can enter a site name. This name can also be used for emails.
- Time zone: The country/region time zone setting is required for correct summer/winter functioning.

- Date & time: The user can adjust the date and time manually. This is automatically synchronised on a weekly basis if the panel is connected to internet with an NTP server. Manual synchronisation is possible by pressing the 'Synchronize' button.
- Application language: The graphic interface can be managed in 4 languages. The user has a choice of English, French, German and Spanish.
- Sound: When the sound is set to 'ON', the unit will activate an alarm when a fault is detected. When this setup is 'OFF', the unit remains on silent mode.



Caution: A unit in silent mode will not sound an alarm for any detected faults, and this may lead to serious consequences. We strongly recommend the user set the sound option to 'ON'.

- Event log file size: The unit can store up to 5000 event log. However, such a large event log is not necessary and it will take a few minutes to be reviewed. The user can choose the number of events to be displayed: 10, 100, 250, 500, 750, 1000, 2000, and 5000. The SD card can hold an unlimited number of events.
- General relay: The user can choose a relay from 1 to 8, or choose not to use it by selecting 'off'. This general relay is intended for the detection of any type of fault appearing on one of the sense cables, leaks, or cable breaks at the end of circuit (termination plug out).

The general relay will also switch in case of system fault (such as one FG-RELAYS box offline)

If the general relay is not used, it's still possible to set a relay on a virtual cable (first unused cable of each circuit) in order to retrieve the end of circuits faults.

Reactivation of relays: every 6, 12, 24 hours. A user can reboot relays following an alarm. They will be automatically reactivated following a fault or after a delay of 6, 12 or 24 hours.

- Map licences: The Digital Unit gives users the possibility to add maps to zones equipped with sense cables. This function is subject to licensing and is locked as standard. A code is required to unlock it and must be typed into the field provided and validated by pressing 'enter'. A message will appear in the event of an invalid code. In the case of a valid code, this field disappears from the menu.

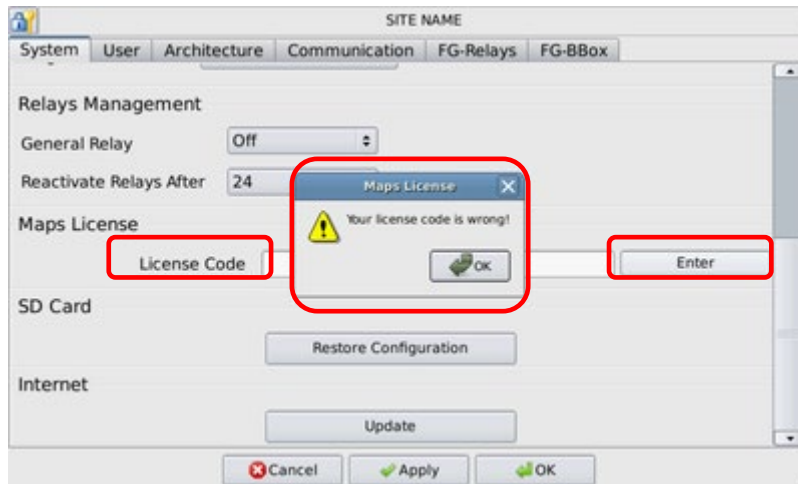

- SD card: In the case of data loss (manipulation error, unit replacement...) the setup can be restored via the SD card. This is the case for all setup configurations in the 'System', 'Users' and 'Communication' tabs. Click on the 'Restore Setup' button to copy the SD Card file to the unit's internal memory. You will be asked to confirm.

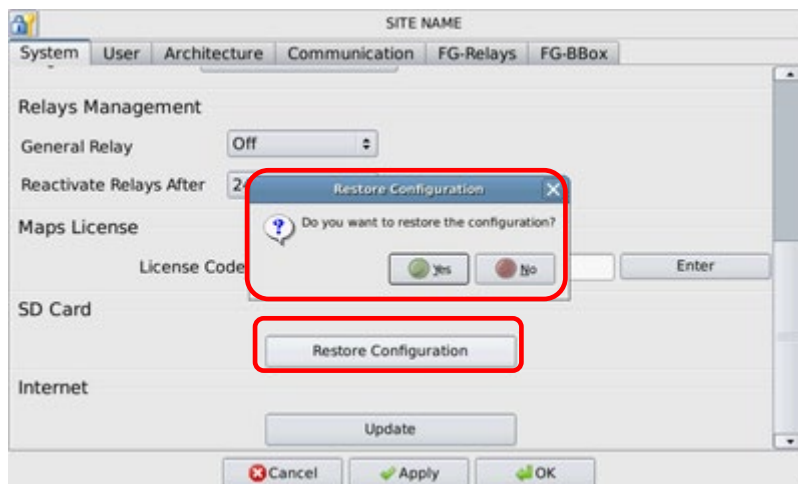

The following message appears if the SD card cannot be found.

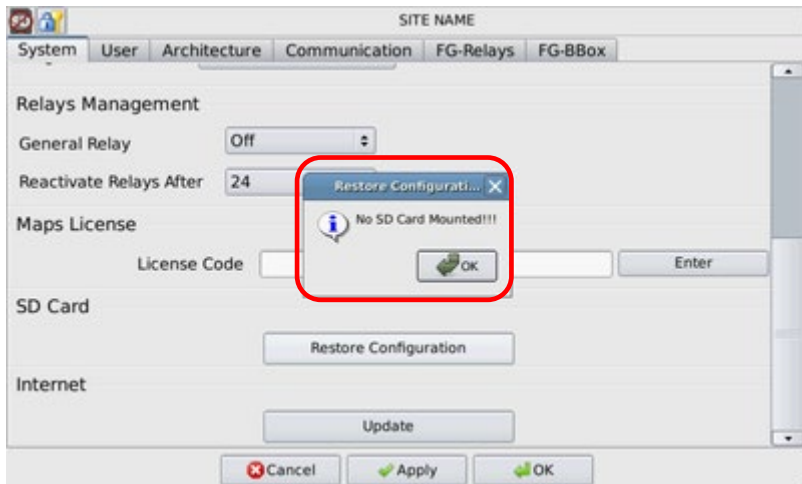

If the version is not adapted to your system, an error message will appear. In this case, please contact TTK to obtain a translation of the file adapted to your Digital Unit.

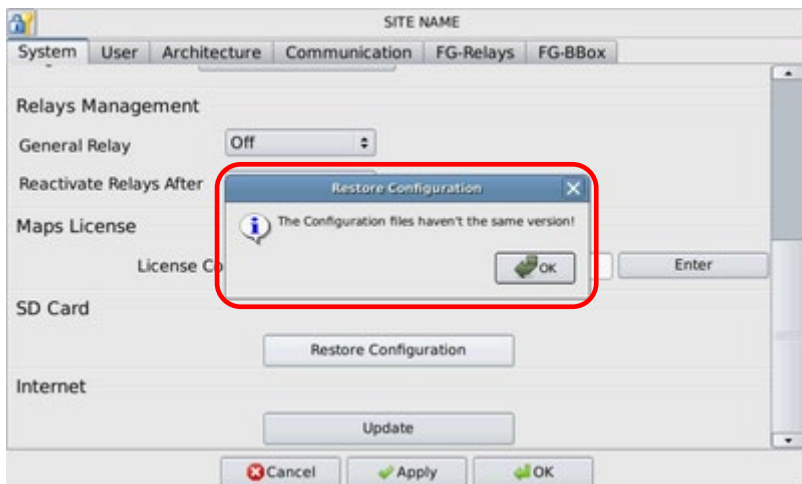

- Internet: If your Digital is connected to the Internet, it can be updated by pressing the corresponding button. You will be asked to confirm.

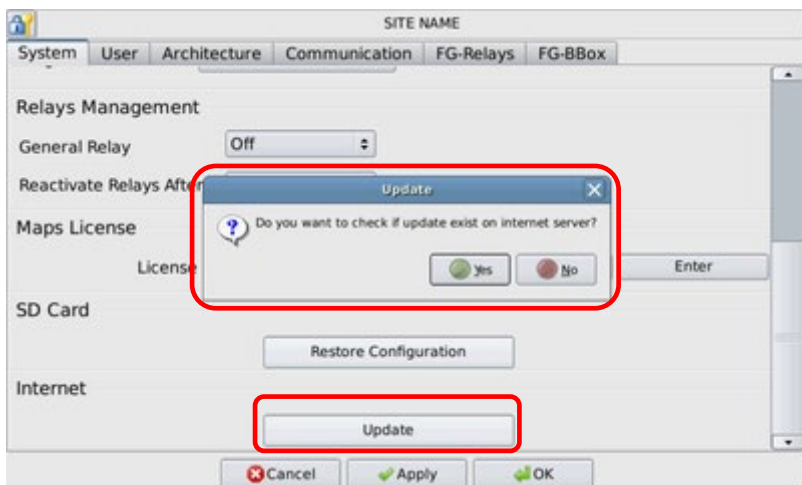

- If the Digital Unit is already up-to-date, the following message will appear.

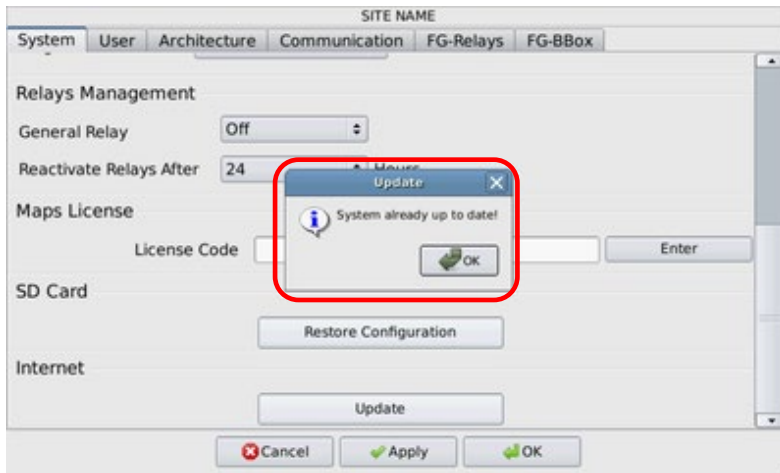

The updating procedure is fully automatic and can last up to 15 minutes depending on the speed of your connection to the servers. The following messages will appear in this order.

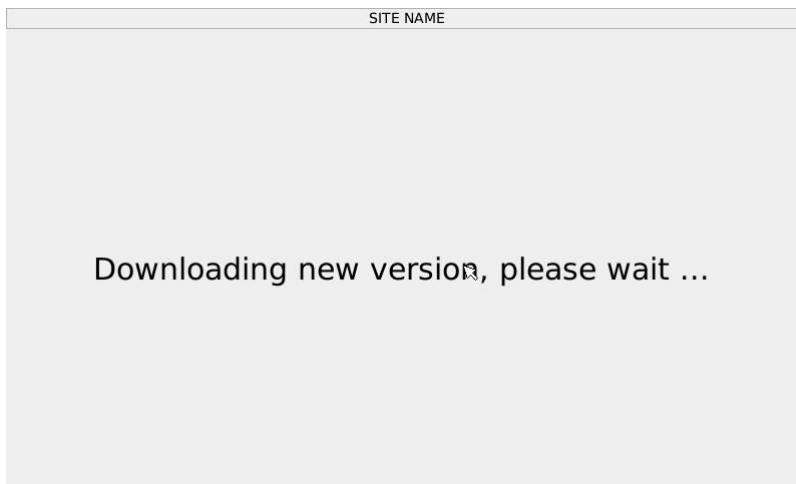

- Then

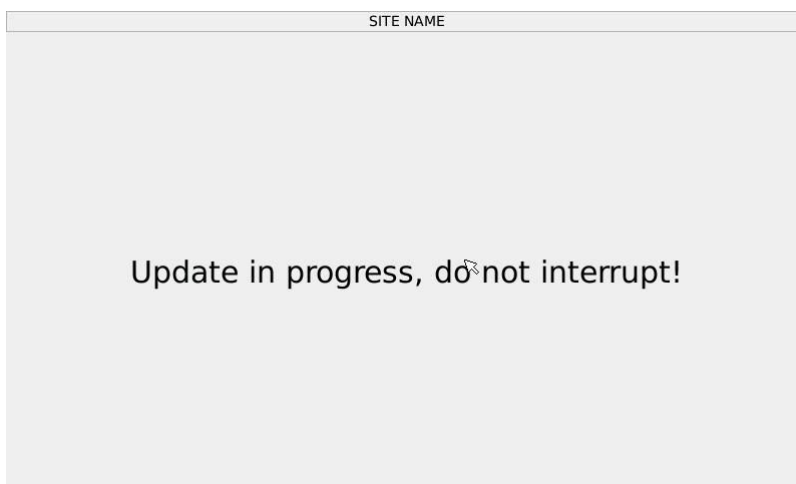

It is also possible to update without an Internet connection using the SD card. To do this, you will find the internal software updates at <http://www.ttkuk.com/water-acids-leak-detection/products/software/>. Copy the file 'update' onto the Digital Unit's SD card, and once the SD

card is reinserted into the Digital Unit, go to the 'Setup' menu. The following screen will automatically be displayed.

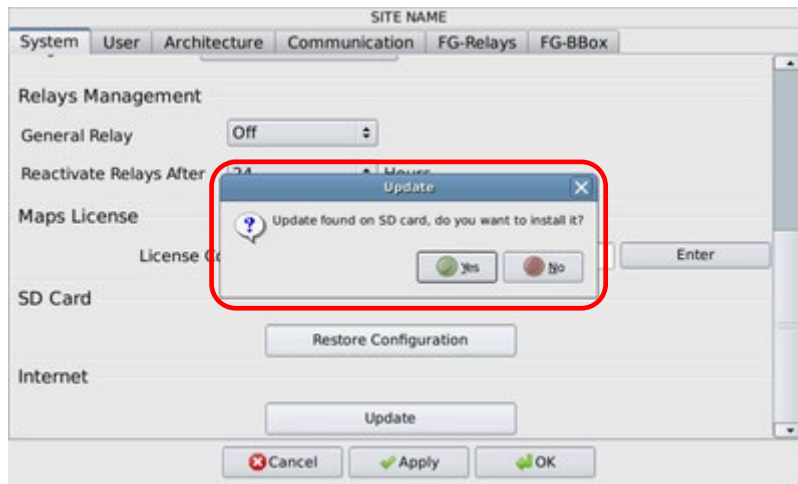

2.1.2 'User' tab

Home → Setup → User (1/2)



Home → Setup → User (2/2)

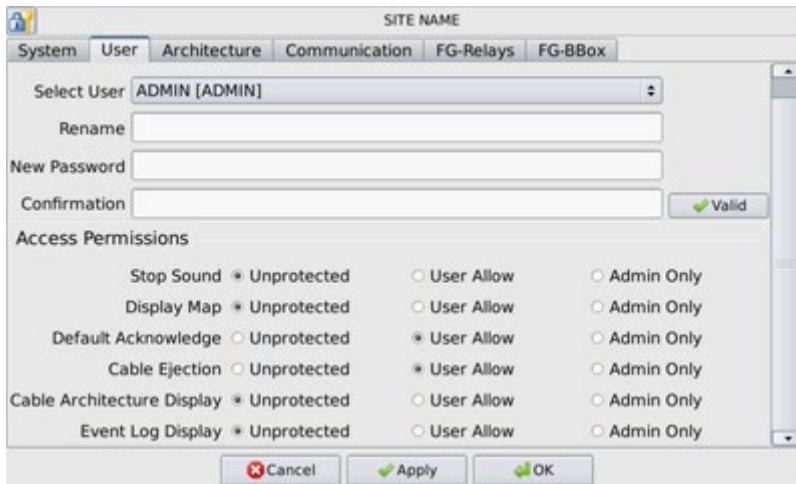

- User management: The administrator can modify the names and passwords for all users. Each change must be validated in order to be taken into account. You will be asked to confirm.

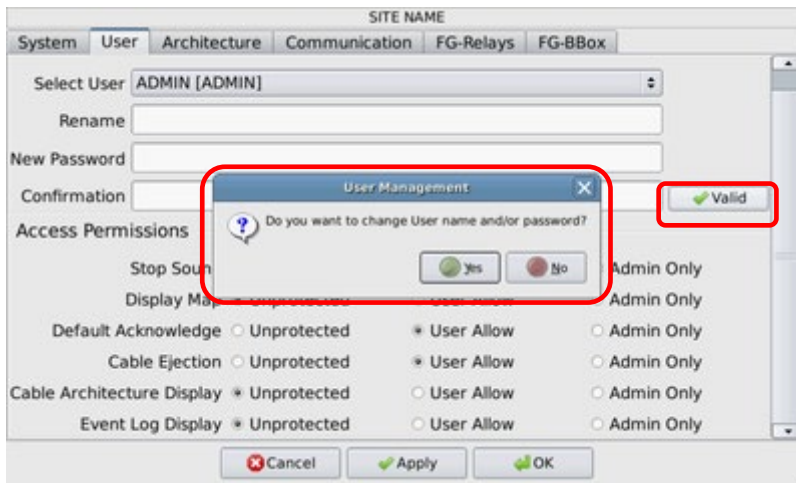

- A warning message will inform the user in the event of an error.

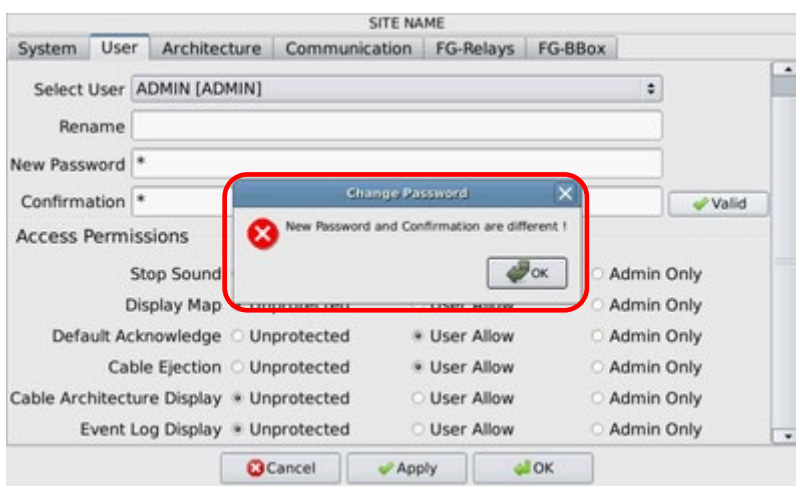

- The administrator can choose to activate or deactivate users (2 to 5) by ticking or unticking the 'Used' field.

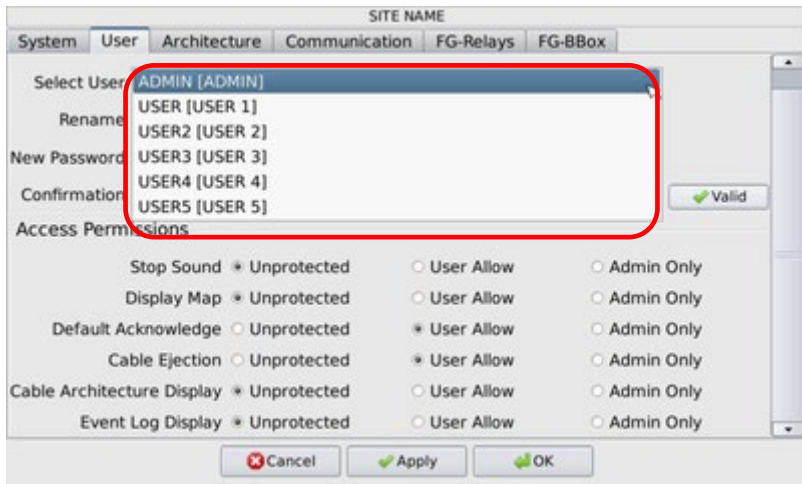

- Access rights: this allows the level of protection to be defined through the use of a password (three levels) in order to stop alarms, display maps, reboot following fault, eject a cable, display list of tables, display event log.

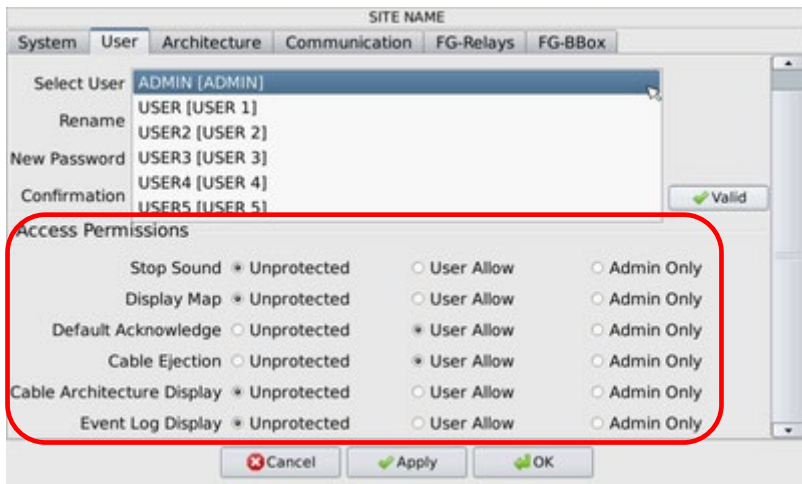

2.1.3 'Communication' tab

Home → Setup → Communication (1/3)

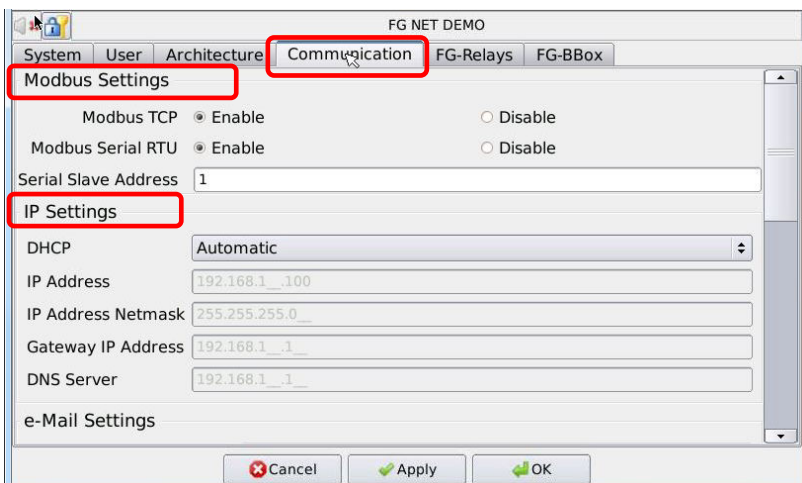

Home → Setup → Communication (2/3)

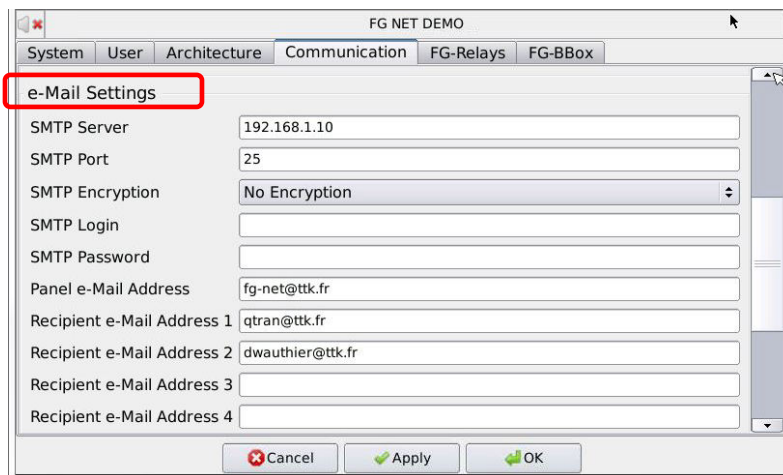

Home → Setup → Communication (3/3)

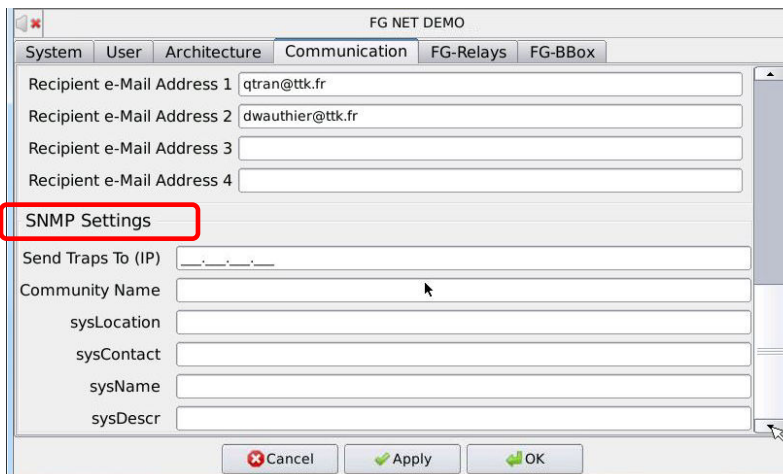

Modbus Setup:

- The user can enable or disable the Modbus TCP feature and/or the Modbus RTU series.
- When the Modbus RTU series is active, you need to specify a slave number for the unit. In the event of multiple stations, assign a different slave number for each unit.

[See Chapter III, paragraph 4.3 -Modbus Communication](#)

IP setup:

A connection to a central computer network allows you to:

- Send emails in the event of an alarm
- Send SNMP Traps in the event of an alarm
- Update firmware using the dedicated button in the 'System' tab. Internet connection required.
- Send a backup of the setup file to the TTK servers during Internet updates. Internet connection required.

- Synchronise the clock with NTP servers. Internet connection is required except when using an NTP server on the local network.

Other features will be available soon.

The parameters below must be supplied by the client's I.T. department.

- DHCP: Allows you to automatically receive the IP settings of the network (DHCP) or to configure them manually (see below)
- IP address: Enter an IP address for the unit. The MAC address is EC:46:44:xx:xx:xx (see the serial number for the last 6 characters).
- Subnet mask: Enter the subnet mask.
- Gateway: Enter the IP of the gateway.
- DNS Server: enter the domain name.

E-Mail setup:

- SMTP server: Enter the server to send emails.
- SMTP port: The default port is 25, but it can be changed depending on the network architecture of the site
- Encryption: The available options are 'no encryption', or 'TLS encryption', or 'SSL encryption'. The SMTP port must be adapted to the chosen option. In general, the default ports are 25, or 465 (SSL), or 587 (TLS).
- SMTP ID: Optional, if the SMTP server requires it, otherwise leave blank.
- SMTP password: Optional, to enter only in the case of SMTP ID
- Unit e-Mail address: Allows you to define a sender address, the unit itself never receives emails
- Recipient e-mail address: Addresses to which the central will send the emails in the event of an alarm. Up to four recipients, only one address per field.

SNMP setup:

- Send Traps To (IP): IP Address of the SNMP server, alarm messages in plain text in the following format → Source 192.168.1.137; Description '2012.10.24 10:47:51 leak at 14m resolved NAME_CABLE [2_07]'.
- Community name: Name of the group in which the unit is located, in general 'PUBLIC'.
- sysLocation: Free text, short description of the unit's location.
- sysContact: Free text, person to contact in case of problem.
- sysName: Free text, name of the system.
- sysDescr: Free text, short description of the system.

2.1.4 'FG-RELAYS' tab

Home → Setup → FG-Relays

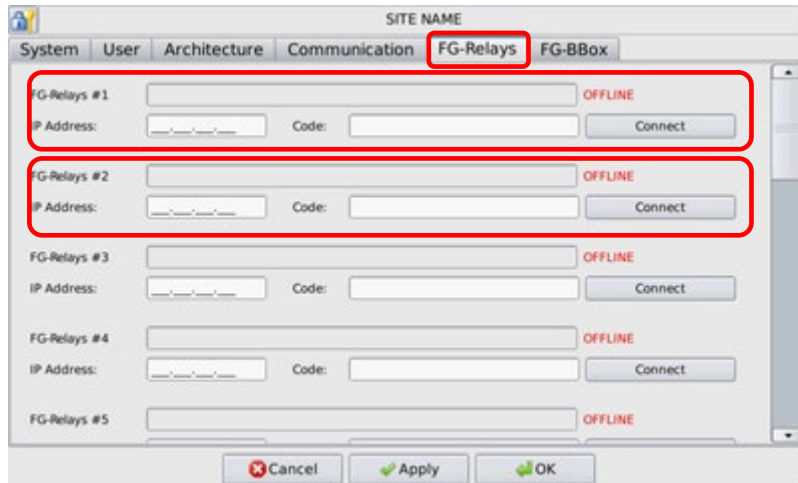

- FG-RELAYS introduction: Up to 16 FG-RELAYS can be connected and managed by FG-NET through the LAN. Every FG-RELAYS offers 24 additional relays, for a total of (16x24) 384 additional relays that can be connected to one FG-NET and installed anywhere on the network.
- Pairing: Before using FG-RELAYS, we must create a link between FG-RELAYS and FG-NET. Make sure both devices are on the same network and set IP's
 - For FG-NET, [see Chapter III Paragraph 2.1.4 – Communication tab](#)
 - For FG-RELAYS, [see Chapter IV Paragraph 1 – FG-RELAYS](#)
 Enter the FG-RELAYS IP and the linking code, and press the “Connect” button. The FG-RELAYS board name will appear automatically and the status will show “online”.
- Once FG-NET linked to one or more FG-RELAYS, go to the ‘Cables’ tab to set the relays in case of leak or cablebreak alarm.

[See Chapter III, paragraph 2.3 – Cables tab](#)
- The connection between FG-NET and FG-RELAYS is controlled by FG-NET. In case of failure for any reason, an alarm will appear on FG-NET, and the general relay will be activated.

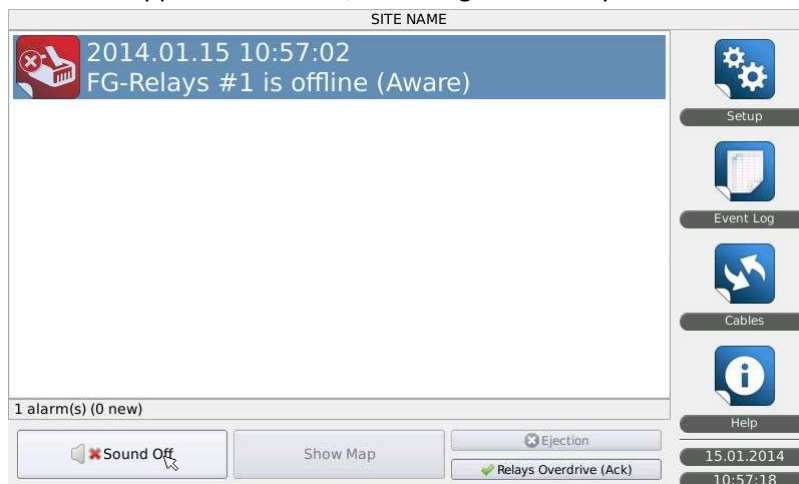

2.1.5 'FG-BBOX' tab

Home → Setup → FG-BBOX

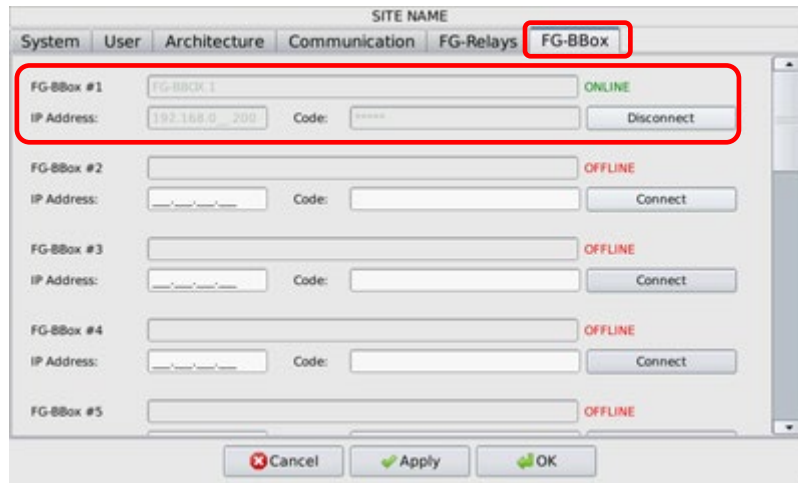

- FG-BBOX introduction: Up to 16 FG-BBOX can be connected and managed by FG-NET through the LAN. Every FG-BBOX expands FG-NET to manage two additional circuits of sense cables.
- Pairing: Before using FG-BBOX, we must create a link between FG- BBOX and FG-NET. Make sure both devices are on the same network and set IP's
 - For FG-NET, [see Chapter III Paragraph 2.1.4 – Communication tab](#)
 - For FG-BBOX, [see Chapter IV Paragraph 2 – FG-BBOX](#)Enter the FG-BBOX IP and the linking code, and press the “Connect” button. The FG- BBOX board name will appear automatically and the status will show “online”.
- Once FG-NET linked to one or more FG-BBOX, go to the ‘Cables’ tab to set the relays in case of leak or cablebreak alarm.
[See Chapter III, paragraph 2.3 – Cables tab](#)
- The connection between FG-NET and FG-BBOX is controlled by FG-NET. In case of failure for any reason, an alarm will appear on FG-NET, and the general relay will be activated.



2.2. Events log



This menu is for viewing the recorded event history.

Up to five thousand (5000) events can be stored in the event log on a FIFO (first-in-first-out) basis.

The number of events displayed in the event log can be adjusted in 'Setup', then 'System', then 'size of event log'. [See Chapter III Paragraph 2.1.1 – System tab](#)

Three drop-down lists allow you to filter the event log by:

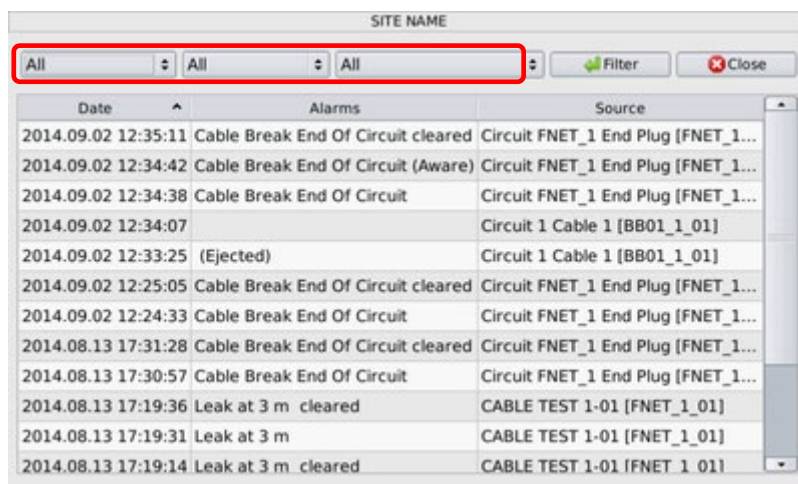

1. Type of alarm (leak, cable break or external devices)

The screenshot shows a software interface for filtering alarms. A dropdown menu is open, showing three options: 'All', 'Leak', 'Cable Break', and 'External Device'. The 'Leak', 'Cable Break', and 'External Device' options are highlighted with a red rectangular box. The background shows a table of alarm events with columns for Date, Alarms, and Source.

Date	Alarms	Source
2014.09.02 12:34:42	Cable Break End Of Circuit (Aware)	Circuit FNET_1 End Plug [FNET_1...
2014.09.02 12:34:38	Cable Break End Of Circuit	Circuit FNET_1 End Plug [FNET_1...
2014.09.02 12:34:07		Circuit 1 Cable 1 [BB01_1_01]
2014.09.02 12:33:25	(Ejected)	Circuit 1 Cable 1 [BB01_1_01]
2014.09.02 12:25:05	Cable Break End Of Circuit cleared	Circuit FNET_1 End Plug [FNET_1...
2014.09.02 12:24:33	Cable Break End Of Circuit	Circuit FNET_1 End Plug [FNET_1...
2014.08.13 17:31:28	Cable Break End Of Circuit cleared	Circuit FNET_1 End Plug [FNET_1...
2014.08.13 17:30:57	Cable Break End Of Circuit	Circuit FNET_1 End Plug [FNET_1...
2014.08.13 17:19:36	Leak at 3 m cleared	CABLE TEST 1-01 [FNET_1_01]
2014.08.13 17:19:31	Leak at 3 m	CABLE TEST 1-01 [FNET_1_01]
2014.08.13 17:19:14	Leak at 3 m cleared	CABLE TEST 1-01 [FNET_1_01]

2. State of alarm (new, aware, acknowledged, ejected, or cleared)

The screenshot shows the same software interface as above, but the dropdown menu is open to show five options: 'All', 'New', 'Aware', 'Acknowledged', 'Ejected', and 'Cleared'. The 'New', 'Aware', 'Acknowledged', 'Ejected', and 'Cleared' options are highlighted with a red rectangular box. The background table of alarm events is visible.

Date	Alarms	Source
2014.09.02 12:35:11	Cable Break End Of Circuit cleared	Circuit FNET_1 End Plug [FNET_1...
2014.09.02 12:34:42	Cable Break End Of Circuit (Aware)	Circuit FNET_1 End Plug [FNET_1...
2014.09.02 12:34:38	Cable Break End Of Circuit	Circuit FNET_1 End Plug [FNET_1...
2014.09.02 12:34:07		Circuit 1 Cable 1 [BB01_1_01]
2014.09.02 12:33:25	(Ejected)	Circuit 1 Cable 1 [BB01_1_01]
2014.09.02 12:25:05	Cable Break End Of Circuit cleared	Circuit FNET_1 End Plug [FNET_1...
2014.09.02 12:24:33	Cable Break End Of Circuit	Circuit FNET_1 End Plug [FNET_1...
2014.08.13 17:31:28	Cable Break End Of Circuit cleared	Circuit FNET_1 End Plug [FNET_1...
2014.08.13 17:30:57	Cable Break End Of Circuit	Circuit FNET_1 End Plug [FNET_1...
2014.08.13 17:19:36	Leak at 3 m cleared	CABLE TEST 1-01 [FNET_1_01]
2014.08.13 17:19:31	Leak at 3 m	CABLE TEST 1-01 [FNET_1_01]
2014.08.13 17:19:14	Leak at 3 m cleared	CABLE TEST 1-01 [FNET_1_01]

3. By cable name, end plug or external device (FG-BBOX) name.

The screenshot shows the same software interface as above, but the dropdown menu is open to show two options: 'All' and 'End Plug'. The 'End Plug' option is highlighted with a red rectangular box. The background table of alarm events is visible.

Date	Alarms	Source
2014.09.02 12:35:11	Cable Break End Of Circuit cleared	Circuit FNET_1 End Plug [FNET_1...
2014.09.02 12:34:42	Cable Break End Of Circuit (Aware)	Circuit FNET_1 End Plug [FNET_1...
2014.09.02 12:34:38	Cable Break End Of Circuit	Circuit FNET_1 End Plug [FNET_1...
2014.09.02 12:34:07		Circuit 1 Cable 1 [BB01_1_01]
2014.09.02 12:33:25	(Ejected)	Circuit 1 Cable 1 [BB01_1_01]
2014.09.02 12:25:05	Cable Break End Of Circuit cleared	Circuit FNET_1 End Plug [FNET_1...
2014.09.02 12:24:33	Cable Break End Of Circuit	Circuit FNET_1 End Plug [FNET_1...
2014.08.13 17:31:28	Cable Break End Of Circuit cleared	Circuit FNET_1 End Plug [FNET_1...
2014.08.13 17:30:57	Cable Break End Of Circuit	Circuit FNET_1 End Plug [FNET_1...
2014.08.13 17:19:36	Leak at 3 m cleared	CABLE TEST 1-01 [FNET_1_01]
2014.08.13 17:19:31	Leak at 3 m	CABLE TEST 1-01 [FNET_1_01]
2014.08.13 17:19:14	Leak at 3 m cleared	CABLE TEST 1-01 [FNET_1_01]

The 'filter' button allows you to view the events according to the criteria selected.

At the top of the lists, you can decide in which order to view the events (descending or ascending order) according to the date, the alarm (alphabetical order), or the cable name (alphabetical order).

Date	Alarms	Source
2014.09.02 12:35:11	Cable Break End Of Circuit cleared	Circuit FNET_1 End Plug [FNET_1...
2014.09.02 12:34:42	Cable Break End Of Circuit (Aware)	Circuit FNET_1 End Plug [FNET_1...
2014.09.02 12:34:38	Cable Break End Of Circuit	Circuit FNET_1 End Plug [FNET_1...
2014.09.02 12:34:07		Circuit 1 Cable 1 [BB01_1_01]
2014.09.02 12:33:25	(Ejected)	Circuit 1 Cable 1 [BB01_1_01]
2014.09.02 12:25:05	Cable Break End Of Circuit cleared	Circuit FNET_1 End Plug [FNET_1...
2014.09.02 12:24:33	Cable Break End Of Circuit	Circuit FNET_1 End Plug [FNET_1...
2014.08.13 17:31:28	Cable Break End Of Circuit cleared	Circuit FNET_1 End Plug [FNET_1...
2014.08.13 17:30:57	Cable Break End Of Circuit	Circuit FNET_1 End Plug [FNET_1...
2014.08.13 17:19:36	Leak at 3 m cleared	CABLE TEST 1-01 [FNET_1_01]
2014.08.13 17:19:31	Leak at 3 m	CABLE TEST 1-01 [FNET_1_01]
2014.08.13 17:19:14	Leak at 3 m cleared	CABLE TEST 1-01 [FNET_1_01]

2.3. Cables

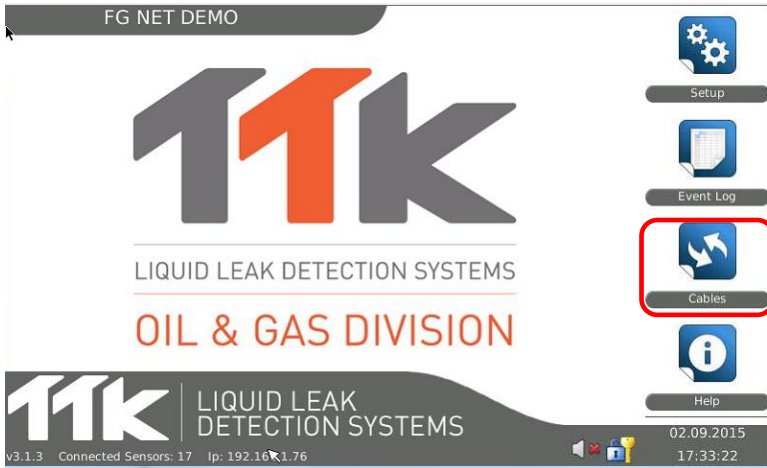

This menu allows you to view all sense cables connected to the FG-NET unit and FG-BBOX unit (if connected). It contains a pull down menu with choice of unit source. Under 'FG-NET circuits' pull down menu, three sub-menus are available: 'circuit 1', 'circuit 2' and 'circuit 3', as below.

Home → Cables

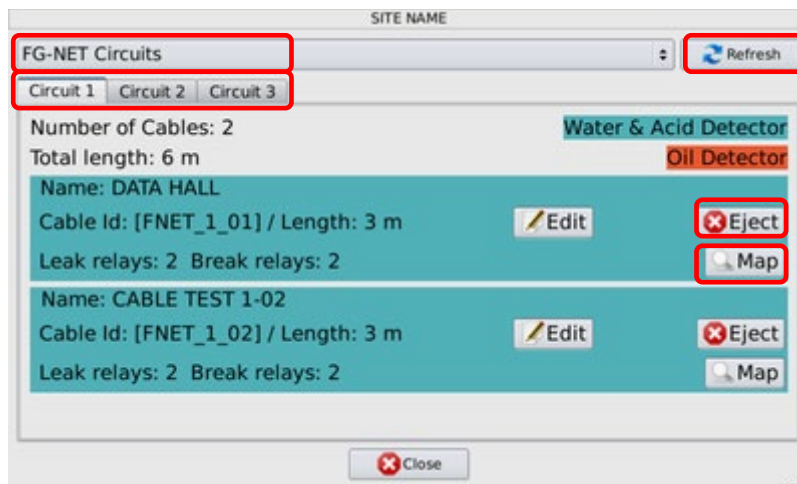

In case of one or several FG-BBOX are connected, under 'FG-BBOX' pull down menu, there are two sub-menus: 'circuit 1' and 'circuit 2'.

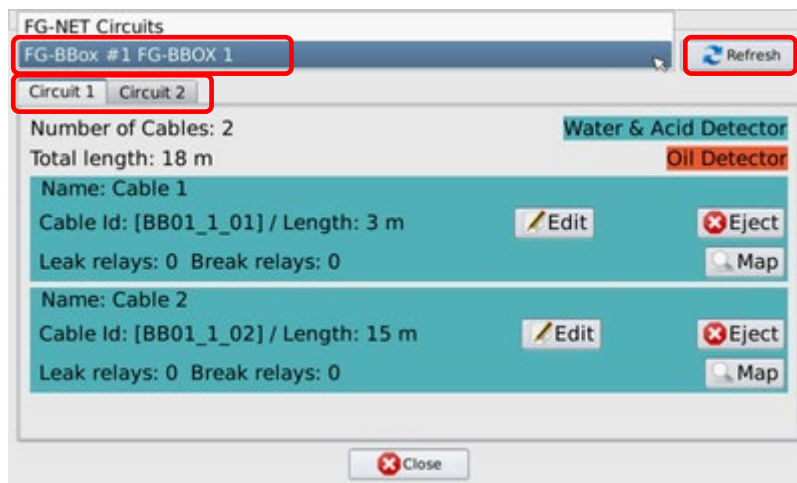

Refresh: This button allows you to perform a manual scan of the circuit in order to display modifications in the architecture of the installation. The scan takes a few seconds and a progression bar is displayed.

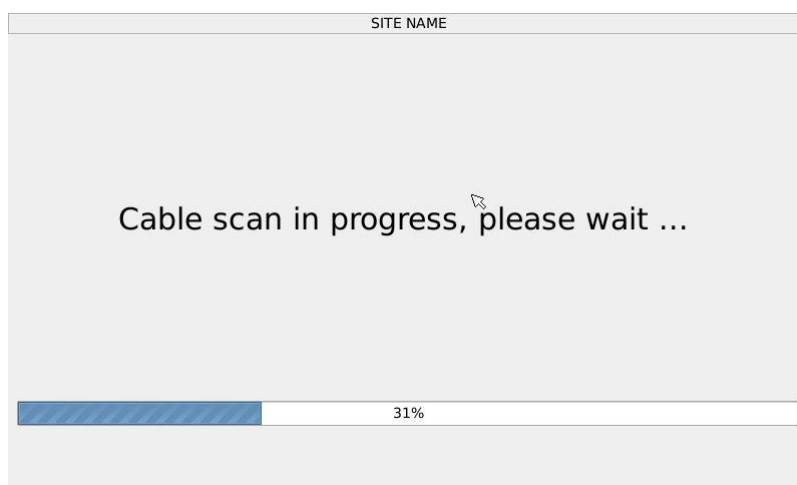

2.3.1. 'Circuit 1, Circuit 2, Circuit 3' tabs

These tabs give the user a general overview of the site installation on each circuit. The sense cables are grouped by zone (in case of cable associations) in a coloured frame, blue for water/acid sensors, and orange for oil/solvents sensors.

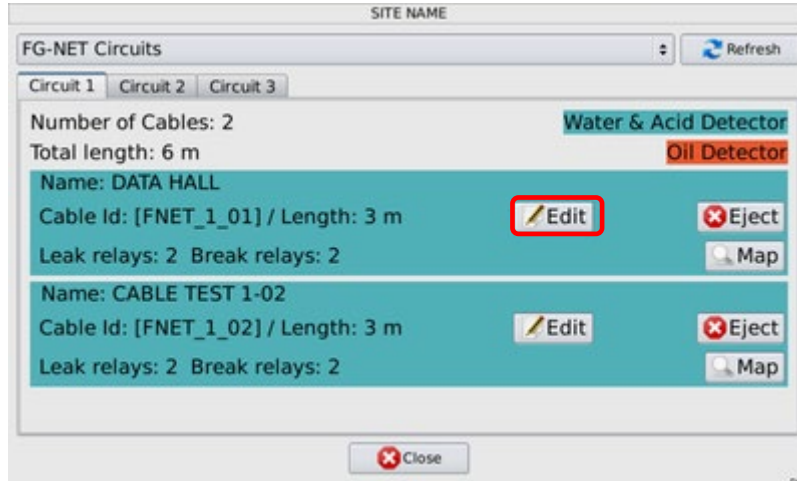

Edit:

The 'Edit' button on every sense cable enables you to rename the concerned sense cable, associate the cables with each other and set up the relays.

Click on the 'Edit' button, the unit asks to enter the password.



Tips: The unit has a timeout function in all protected menus, in order to avoid entering the password every time during the system settings on site. The "unlocked" status is shown by a green lock icon on all screens. Click on the lock to stop the function.

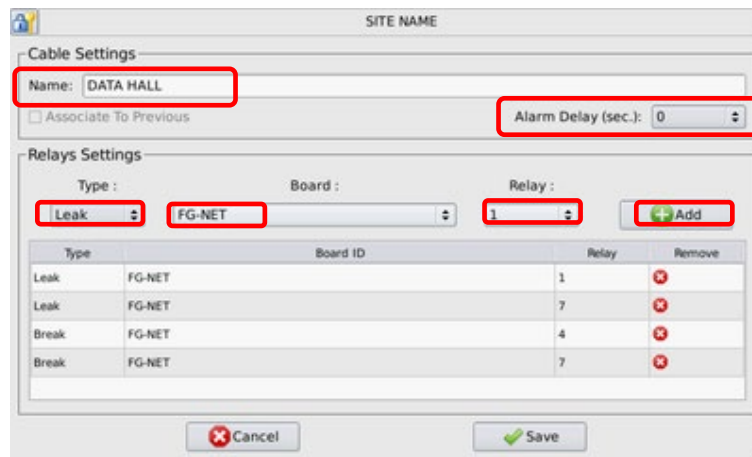

Cable settings:

- Name: The cables are spread over two or three circuits with a maximum of 40 cables per circuit. Each cable has a unique ID – ‘Box name_Circuit number_ Cable number’.
 - Example 1: ‘FNET_1_07’ is the cable connected on FG-NET unit, circuit 1, n°7.
 - Example 2: ‘BB01_1_07’ is the cable connected on FG-BBOX#1, circuit 1, n°7.
- The user can also add a name to facilitate the identification of cable, for example: ‘Data Hall’.
- When a FG-OD sensing cable is plugged on the system, the type of cable is shown in the header right after the name and cable length. Example: Cable [1_01] – 7 m Oil Detector
- ‘Associate to previous: This option allows you to create a group of cables which all share the same parameters. This means all alarm location points are set for the whole group and not just a single cable. However, each cable remains independent and retains its ability to detect leaks. For example: Three 15m cables are installed within a Data Hall and are associated to each other. If there is a leak on the third cable, the location point would be situated between 30 and 45 metres. This does not mean the system would not detect a second problem on the first cable at 6 metres or a third problem on the second cable at 27 metres.
- Alarm delay (sec.): This new function consists of configuring the unit to alert a fault and to only display it following a certain period of time (during which time, it must be confirmed). Adjustable for 0, 30, 60, 90 ... 300 seconds.

Use with precaution: This is a useful setting to avoid sounding an alarm for a simple water drop which dries within a few seconds.

Relay settings:

- Type (Leak/break): For every sense cable, the user can choose the type of fault (leak or cablebreak).
- Board: to choose a sense cable connected on which box: FG-NET or one FG-BBOX. Example as below screen shot:

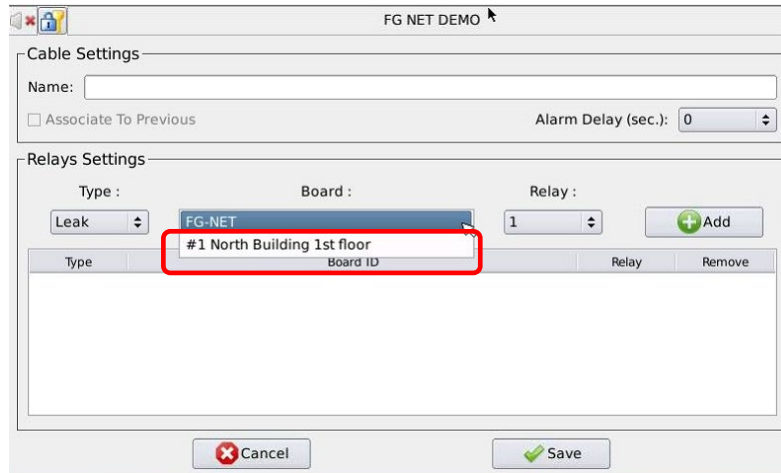

- Relay: to choose the relay number to activate in case of alarm.
- Add: Once finished the configuration, press “Add” button to add it in the list of relays linked to that cable.

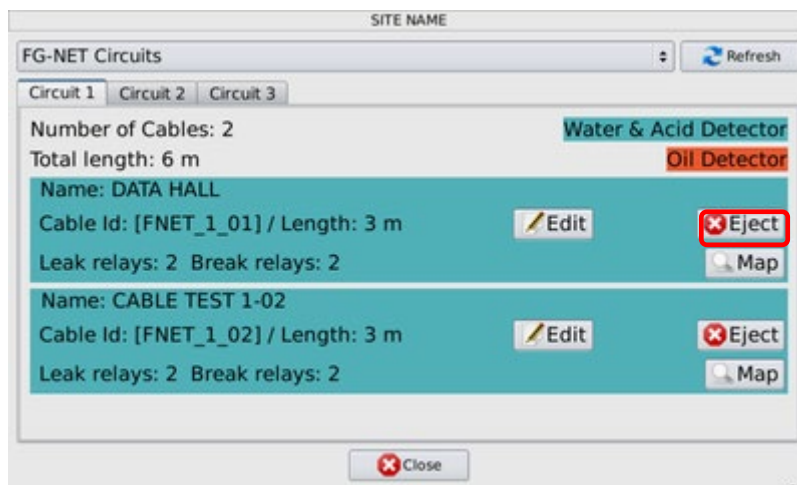

Eject:

The ‘Eject cable’ button allows you to exclude each section of the cable independently over a given period of time up to 72 hours. Any alarm that appears on that section of cable within this ejection period will be ignored.

Press the ejection button of the section concerned, then select the duration of ejection.

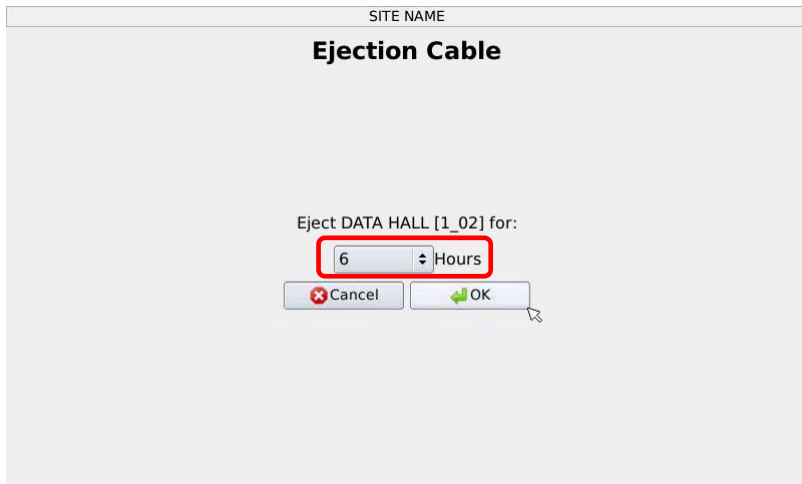

All ejected cables are automatically reactivated at the end of the selected period. The number of ejected cables is displayed on the home screen. Press on the flashing counter to access the list of ejected cables.



All ejected cables can be reactivated manually without having to wait until the end of the ejection period. To do this, press 'Reactivate'.

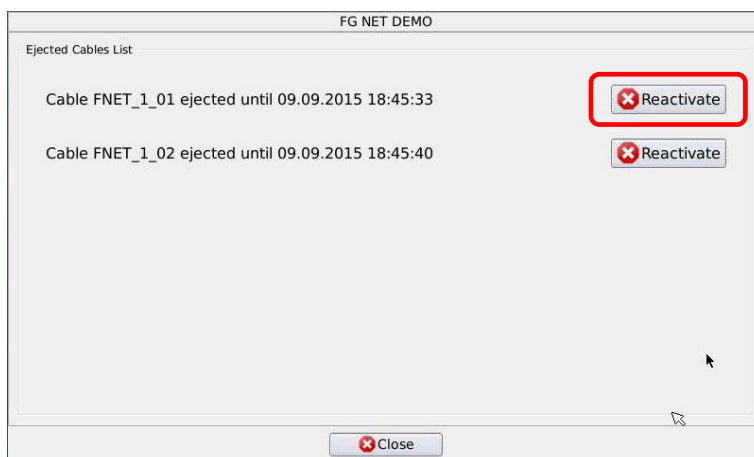

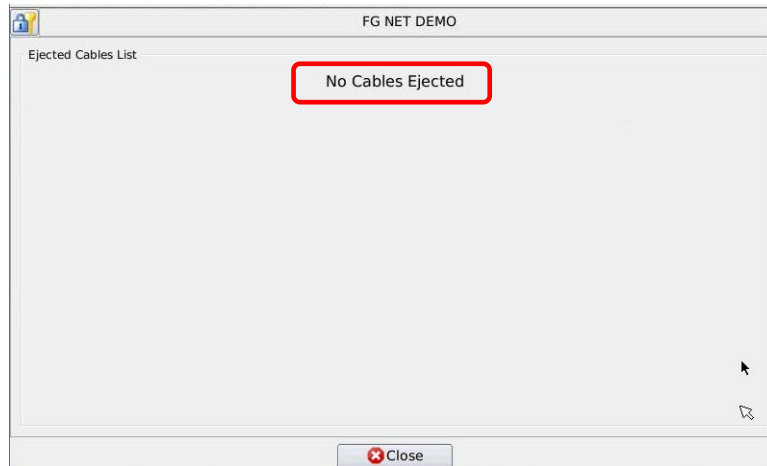

Map:

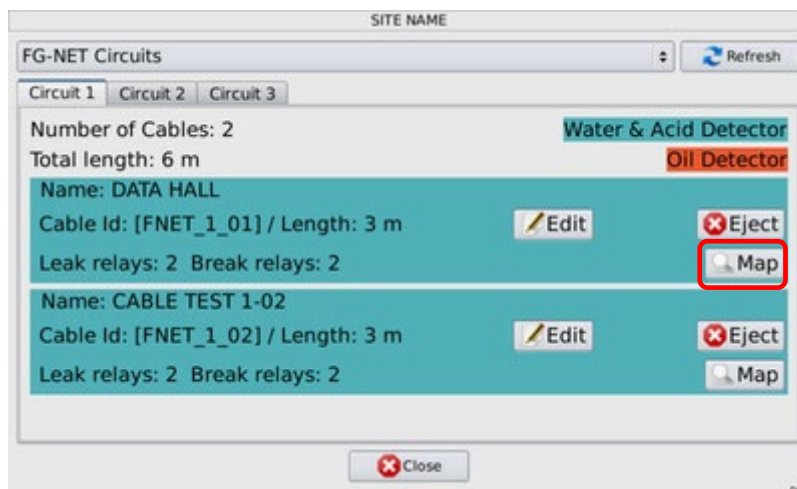

Click on the 'map' button, and the corresponding local floor map will appear (option).

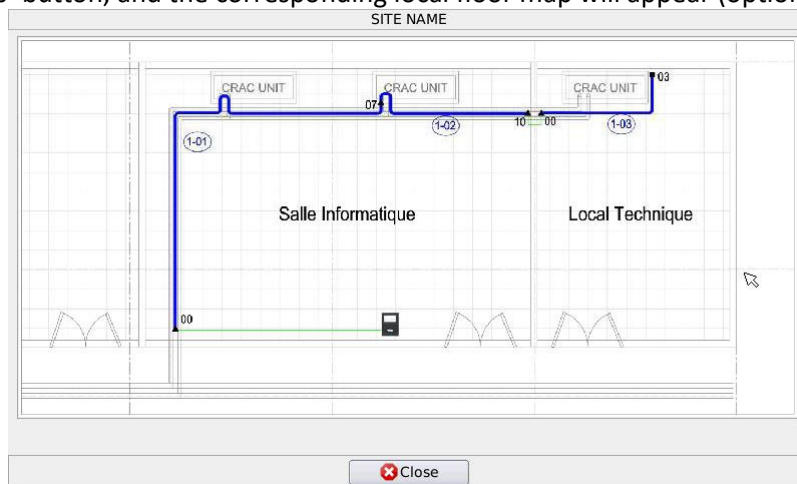

If this function is locked, the unit will display the demonstration maps for cables FNET_1_01, FNET_1_02, and FNET_1_03.

For all other cables, the following message will appear, 'Invalid map'.



2.3.2. Automatic update of cable lists

In the event of modifications on connected cables, the cable list under the 'cables' menu will be updated automatically.

This function also controls the length of sense cables, and the alert will reappear if a sense cable is replaced with one of a different length.

This automatic check occurs as soon as the system is initially booted, and every time all circuit breakers are determined.

This function guarantees that no sense cable can be deleted from the system without the user having first been notified.

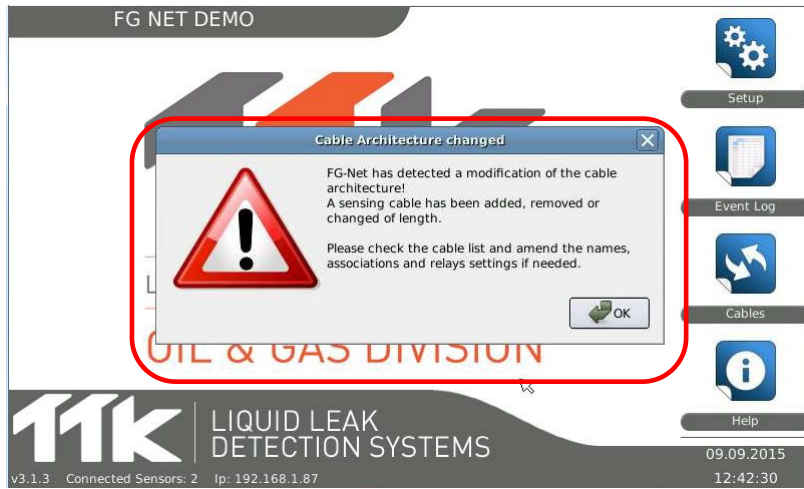

Press the OK button to remove the alert message, and verify the list of installed sense cables, their correct installation, and correct any programming issues if required.

In the event of installation modification, corrections should be made to the system's map and reported to the supervisor (BMS/BMC) in the event of any problems.

2.4. Help

This menu provides global contact details of the manufacturer, an interactive user guide, a Flash code to access specific web content, and all the unit's technical information.



2.4.1 'Contact' tab



The address, phone number and other contact details of local suppliers can be displayed by modifying the 'contact.html file', and are also available in 'contact' sub-menu available on the SD Card.

The whole list contains the contact details for TTK suppliers and manufacturers across the world.

2.4.2 'User Guide' tab

This sub-menu contains the interactive user guide.



2.4.3 'Flash code' tab

The Flash code (or QR code) can be scanned using a smartphone and will direct you to the FG-NET website. www.FG-NET.com

This sub-menu provides all documentation relative to the system.



2.4.4 'About' tab

This tab contains all the technical information pertaining to the unit.

SITE NAME			
Contact	User Guide	Flashcode	About
Serial number:	FG-NET-EC4644000390		
Starting date:	07/01/2014		
Firmware release version:	3.0.0		
Update version:	gitr946+369226		
Kernel version:	3.4.40 #5 PREEMPT Tue Apr 30 16:42:40 EEST 2013		
IP address:	192.168.0.134		
Modbus slave address:	1		
Close			

Serial number:

A unique number is attributed to each Digital Unit. This number is required should you wish to have access to your codes, map licences, and more.

Starting Date:

This date is automatically created by the unit when commissioning the system.

Firmware version:

The software version is also displayed at the bottom right of the home screen.

Update version:

This information can be requested in the event of a system fault.

Kernel version:

This information can be requested in the event of a system fault.

IP address:

This is the IP address assigned to the unit, either in automatic mode (DHCP); or manual mode.

[See Chapter III 2.1.4 - IP Setup](#)

Modbus slave address:

The Modbus slave number assigned to the unit for the Modbus RTU serial (RS232-RS422/485). No slave number is necessary for the Modbus TCP.

[See Chapter III 2.1.4 - Serial Link](#)

2.5. SD Card

The unit's SD card is not strictly required for its operation.

In the event of its absence, only certain functions will cease to function:

- Display of embedded maps
- Display of local contact.
- The file history and auto-control saves on the SD card of the setup file.

These functions will be automatically restored when the SD card is reinserted.

An icon appears in all menus when the SD card is missing.



The SD card contains the following elements.

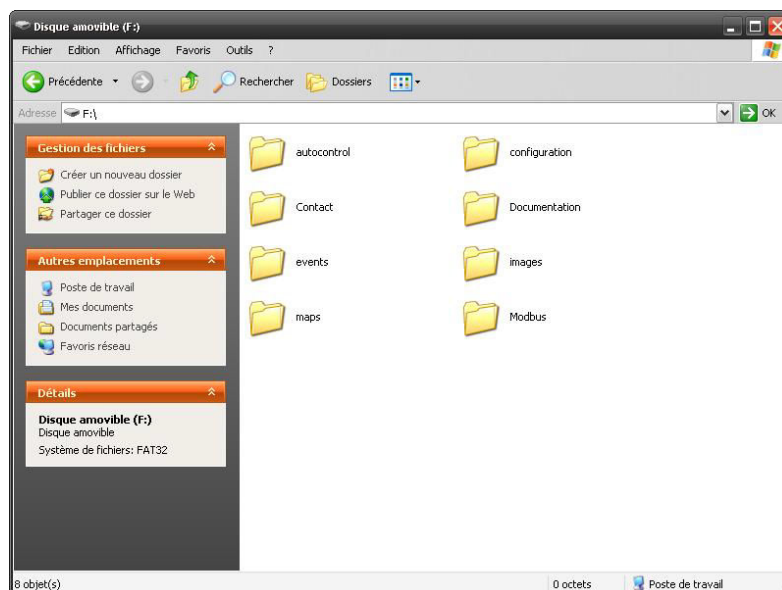

1/Auto control:

The auto control files in PDF format are automatically created by the unit.

The last file is located at the root of this file.

The old files are saved in the 'Archives' directory with a maximum of one file per day.

A new file is generated each week, or upon leaving the 'Setup' menu.

To generate a new file, go to 'Setup', and then exit by pressing the OK button.

2/Setup:

This file contains a backup of the setup file located in the internal memory of the system.

In the event of a system failure, if the unit needs to be replaced, insert the SD card containing this setup file into the new unit, then go to 'Setup' and press the 'Restore Setup' button located in the 'System' tab.

This will reload the setup file in the unit's internal memory.

We strongly recommend that you keep a copy of this file in your records once the installation is complete.

You can edit this file using a text editor (Microsoft WordPad, Open Office Writer ...) in order to program the unit easily with a computer.

3/Contact:

The first tab in the 'Help' menu is 'Contact', showing the list of TTK offices around the world.

You can view the custom information at the top of the list by modifying the 'contact.html' file.

Open with Microsoft Word or any HTML editor.

4/Documentation:

Here you will find several documents including technical data sheets, a User Guide, an Installation Guide, a Quick Start Guide and others.

5/Events:

An unlimited event log is saved in this file under the name 'events.txt'.

Open with Microsoft Excel.

For updated systems from older versions (before 2.1.0) a copy of the old event log is retained under the name 'log_default.txt'.

6/Images:

When there is no alarm on the system, a slideshow of pictures appears on the home screen.

These files can be located in the 'backgrounds' sub-file.

You can delete, add, or replace these files with your own images with the logo of your company (for example).

Keep the same size and format (*.PNG)

7/Maps:

A map of alarms can be displayed on the unit's screen in the event of a leak or cable break.

A map of the zone can be displayed on the unit's screen via the 'Cables' menu.

All of these maps are stored in this file.

This feature is locked by default.

The maps for the first three sense cables are saved in the unit's internal memory.

Please contact us to receive your unlock code, then go to the 'Setup' menu, in the 'System' tab and enter the code in the 'License Maps' field.

8/Modbus:

In the 'Modbus Table' sub-file, you will find a Microsoft Excel table explaining how to connect to the unit, with information as to what records can be read, and what information you can receive from the system.

This file can easily be modified and supplemented by the list of cables currently installed on site.

In the 'Modscan32 Testing Tool' sub-file, you can find a third party testing tool for the Modbus slaves.

3. WATCHDOG

The FG-NET Digital Unit has an integrated Watchdog function.

This feature continuously monitors the correct functioning of all the features within the unit, and if a problem were to be detected, the Watchdog would proceed with a reboot of the system.

The unit's relay can be used to link all external equipment to the system, the reboot is seamless, and the relay state is retained during the reboot.

The Modbus communication is suspended during the reboot, and automatically resumes when the system is functional again.

Considerable efforts have been made to ensure reliability without compromise, and the FG-NET Digital Unit has undergone several tens of millions of tests without failure.

This additional security, which should never be solicited, assures you a maximum level of reliability.

4. COMMUNICATION SETUP

Operating the FG-NET Digital Unit using TOPSurveillance™ Software

4.1. General

The operation and supervision of the FG-NET Digital Unit is achieved using the JBUS/MODBUS protocol between the FG-NET and the Supervisor (BMS) with the RS232 or RS422/485 serial links.

The JBUS or MODBUS protocol is a master-slave type and was developed to establish a supervision of several devices (the slaves) by one or more masters connected to the same physical support (electrical, optical, radio, etc.). All the supervised devices are simply connected in parallel, using different slave numbers.

The communication is always point-to-point, question-answer type, with only one device using the connection line at a time.

The user of the FG-NET Digital Unit could configure slave numbers from 1 to 247, which allows the supervisor (BMS or TOPSurveillance) to simultaneously operate and connect several TTK FG-NET central units to other security systems.

The TOPSurveillance™ is supervisor software developed especially for liquid leak detection and location with the FG-NET Digital Unit. This software can be installed on a PC or another Microsoft Windows-compatible workstation. The electrical connection between the PC(s) and the supervised central unit(s) is achieved with a series of cables, connected to the PC's serial port and the serial interface available on the FG-NET Digital Unit.

The use of the JBUS protocol permits the download of all the Digital Unit's useful information on the supervision of the leak detection system.

For one central unit and for short serial links (up to 60 m), it is recommended to use the RS232 interface.

To connect several central units on the same communication link, and for distances over 60m, the use of RS422 or RS485 is compulsory. Both these interfaces are implemented on the FG-NET central unit.

It can also be necessary to use an RS232C/RS422 (or /RS485) converter connected with very short RS232C cable (< 1-2 m) to the computer. The cable (RS422 type) between the converter and the central unit(s) should have characteristic impedance of about 120 Ohms and the total length of this cable should not exceed 1000 m.

(™) FG-NET and TOPSurveillance are trademarks of TTK S.A.S.

4.2. Schematics

Physical representation of a sample site with several FG-NET Digital Units connected to the same supervisor.

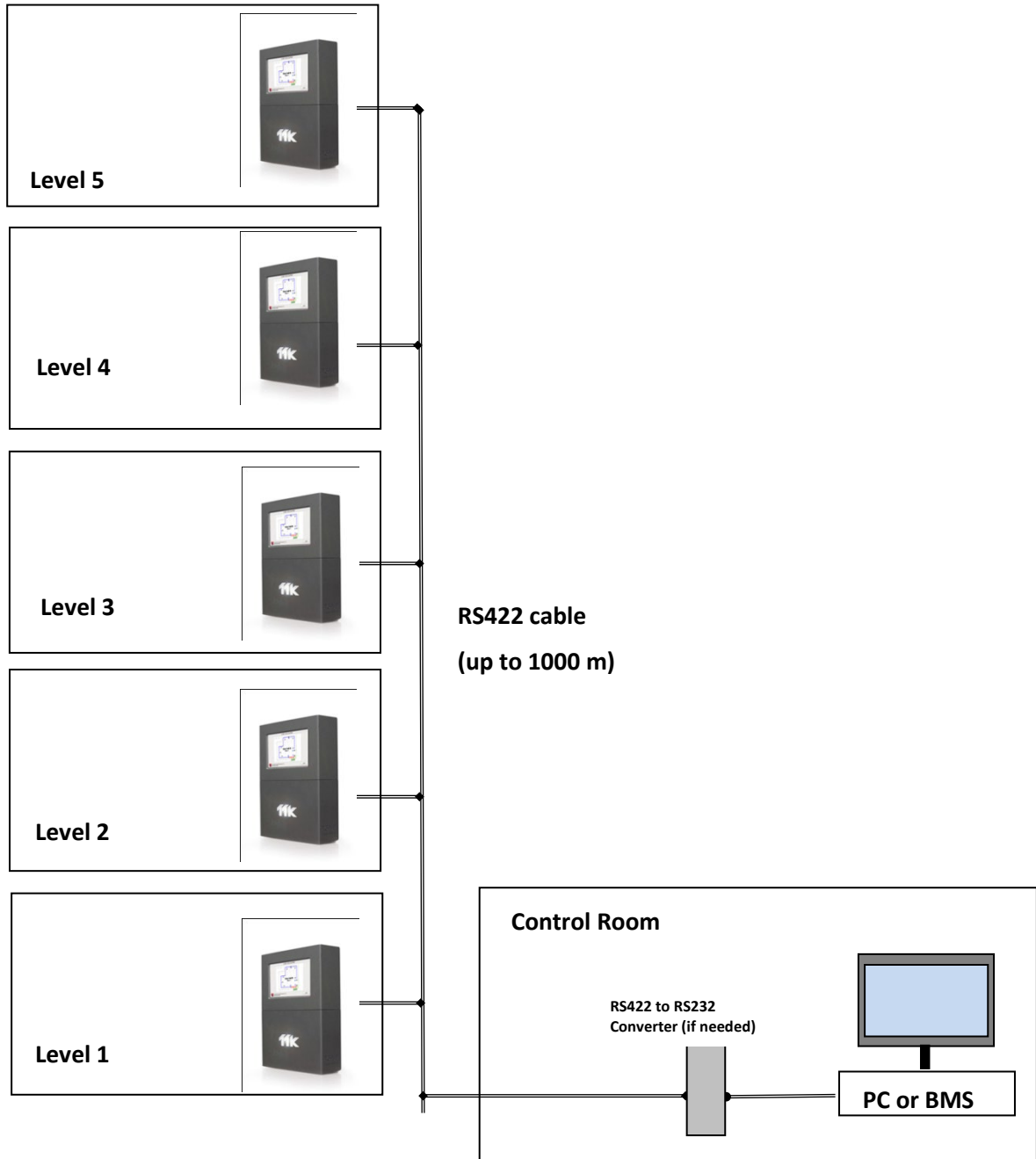

Details of FG-NET installation on one level

Remarks:

1. The jumper cable is a TTK BUS 8723. The maximum distance for a connection between the unit and a jumper or between two sense cables is 150 m.
2. The total length of the installed cables (sense cables plus jumper) per zone should not exceed 1,200 metres.

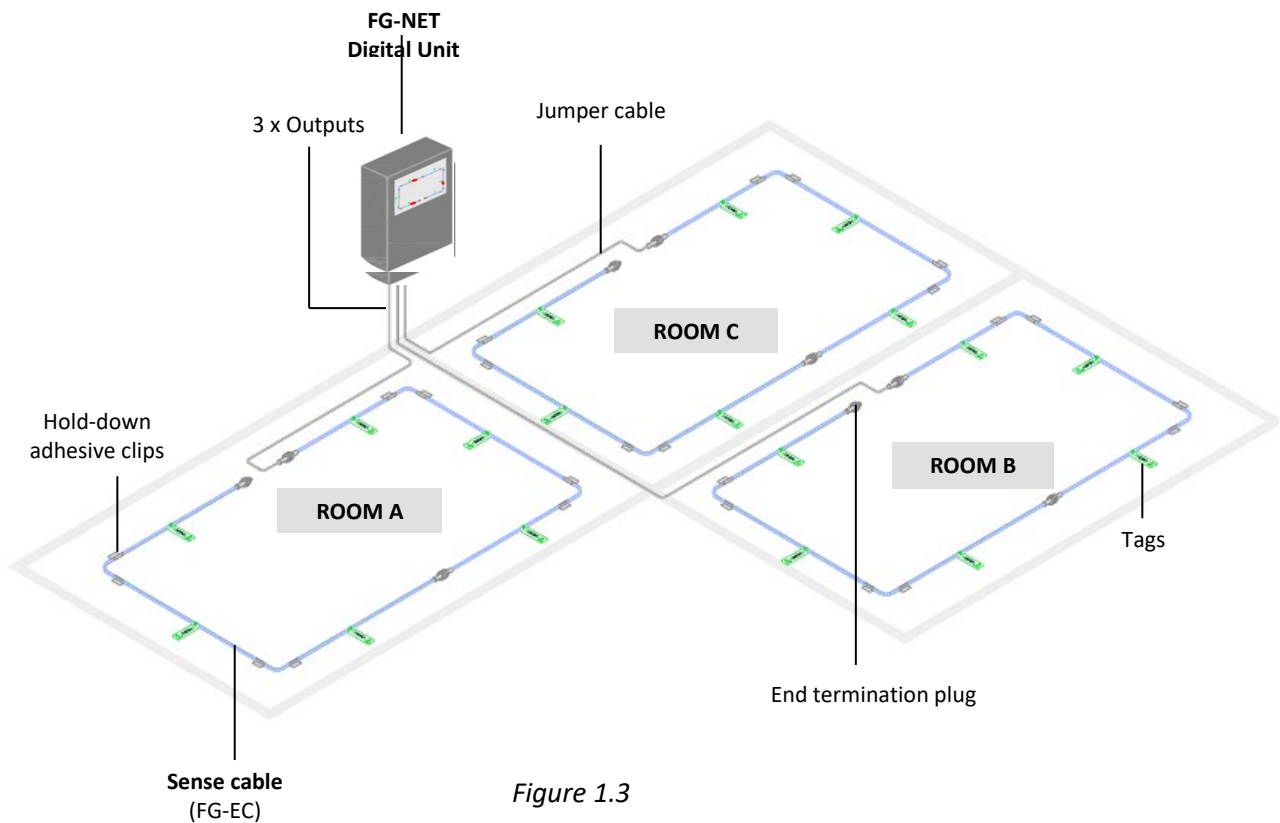

4.3. Modbus communication

The integration on the FG-NET JBUS/MODBUS protocol Digital Units permits the supervision of the current status of all connected sense cables. The two types of alarms – leak and cable break – are coded using different flags and the location is represented in metres.

Following the creation of new features, a new Modbus Table has been created for the FG-NET; however former Modbus Table has been retained in parallel for compatibility reasons.

The former Modbus Table can be found in the FG-SYS Digital Unit documentation.

Cables connected on FG-BBOX work on the same principle, only the MODBUS register addresses are different.

Physical connection

The information provided by the Digital Unit can be exploited in different ways:

- Modbus TCP (Modbus over IP) port 502.
- Serial link RS232 or RS422/485.

The serial link is asynchronous.

The serial link and Modbus protocol settings are as follows:

Serial port setup: 9600 B, 8 data bits, 1 stop bit, no parity;

Communication protocol: JBUS or MODBUS, function 3 or 4;

Slave number: 1 - 247 (configurable);

Maximum number of records read by request: 100

Answer Format:

<i>num. slave</i>	<i>function</i>	<i>nb of Registers</i>	<i>Register 1</i>	<i>Register 2</i>	<i>...</i>	<i>Register n</i>	<i>CRC 16</i>
/ 1, 2... 99 /	/ 3 or 4 /	/ up to 100 /	/ xxxh /	/ xx xxh /	/ ... /	/ xxxh / xxxh /	

For the proper functioning of the RS485, it is necessary to connect Rx+ with Tx+ and Rx- with Tx-. In addition, it is essential to complete the line of communication via a two-wire resistance of 120 Ohms.

The connection of the screen is provided on the supervisor side.

The polarisation of communication lines from RS422/485 must be ensured by the supervisor.

It is recommended to provide a break of at least 500 mms between JBUS polls.

Caution!

The simultaneous use of RS232 and RS422/485 interfaces causes the serial interface of the FG-NET Digital Unit to power down.

Interpretation of information

There are three series of Registers for the sense cables state (addresses are expressed in decimals)

The first series (7000) is used for the types of alarm.

- Leak (bit 4)
- Cable break in bus (bit 0)
- Cable break in sense cable (bit 1)
- Cable break in end termination plug (bit 2)
- All cable breaks (resumed bus, plug and sense cable) (bit 7)

The second series (8000) is used for the alarm status.

- New (bit 0)
- Selected (bit 1)
- Acknowledged (bit 2)
- Ejected (bit 3)

The third series (9000) is used for location (in meters) of alarms (bits 0 to 15)

The Register's address to refer to a particular cable with the following layout:

- First digit for the series (7, 8, or 9)
- Second digit for the sense circuit (1, 2, or 3)
- Last two digits for the position of the cable in the circuit (from 01 to 40)

Example: The Type Register for the seventh cable of the second circuit (cable 2_07) will therefore be Register 7207, and the Location Register for the same cable will be 9207.

Finally, four additional Registers provide information on the status of the system.

1. 4096. Digital Unit leak (bit 4) and cable break (bit 7) global status.
2. 4097. Circuit 1 leak (bit 4) and cable break (bit 7) global status.
3. 4098. Circuit 2 leak (bit 4) and cable break (bit 7) global status.
4. 4099. Circuit 3 leak (bit 4) and cable break (bit 7) global status.

Based on client needs and requirements, the user can query the set of Registers, in part, and/or use the additional Registers. This allows for simplified programming and adaptation to the specific BMS/BMC.

Remarks:

The end terminating plug can only encode cable breaks. For a circuit of N cables, it must be read N+ 1 Register (N Registers for the sense cables + 1 Register for the end terminator plug).

An ejected cable can no longer be set with an alarm, so it is normal to not to have any more information in the Type Register (7000).

Only the Status Register (8000) shows that this cable is ejected.

Contrary to what existed in the former Modbus Table, the location expressed in metres is now identical to the value indicated on the unit's screen. It is therefore quite possible to have an alarm located at 472m in the case of associated cables.

Following the supervisor, the charset can be included or not in the interpretation of the response. In this case, the address of the cables will be N+1 (Example: cable 2_07 in address 7208 instead of 7207).

Tips:

An Excel table (ready to complete), and incorporating all this information, is available on the unit's SD card in the 'Modbus' file (or see [Appendix 2](#)).

The 'auto control' file contains a PDF file listing all sense cables connected to the system, as well as their names, lengths, states, and other useful information.

The embedded installation maps (optional) can be saved in the 'maps' folder.

Remove the SD card from the unit, read it using a PC and copy the necessary files (do not delete files) and then return the card to the unit.

The entire unit's information, loaded to its maximum capacity, is searchable using only 10 queries:

1. Types of alarm Circuit 1: Starting address 7101, length 40 Registers
2. Types of alarm circuit 2: Starting address 7201, length 40 Registers
3. Types of alarm circuit 3: Starting address 7301, length 40 Registers
4. States of alarm circuit 1: Starting address 8101, length 40 Registers
5. States of alarm circuit 2: Starting address 8201, length 40 Registers
6. States of alarm circuit 3: Starting address 8301, length 40 Registers
7. Location in metres to alarm circuit 1: Starting address 9101, length 40 Registers
8. Location in metres to alarm circuit 2: Starting address 9201, length 40 Registers
9. Location in metres to alarm circuit 3: Starting address 9301, length 40 Registers
10. Summary faults in unit per circuit: Starting address 4096, length 4 Registers

The Modbus function must be enabled in the unit's 'Setup' menu.

It is necessary to define the number of Modbus slaves when using the serial interface.

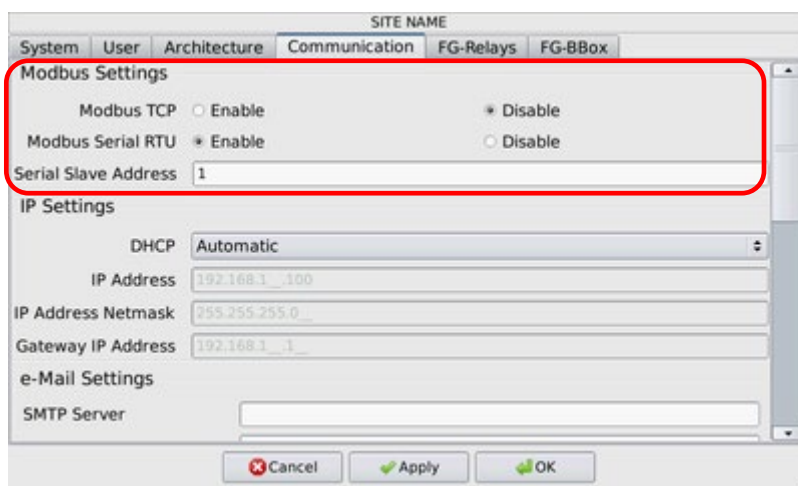

4.4. TOPSurveillance™ Software

The supervising software TOPSurveillance™ is composed of a general JBUS driver plus one or several additional windows used for pin-pointing the alarms on the maps of each protected zone.

The driver questions the supervised central units continually to determine the state of each sense cable. The presence of one or more faults on the sense cable network generates an alarm (visual + sound) in the general driver's window. The warning light is displayed in the sense cable space in each zone. The user can clear the alarm manually and the warning light switches off automatically, once the fault has been dealt with.

The visualisation of the current status of a particular zone is initiated by opening the corresponding zone's window.

As soon as a leak or a cable break appears, the sound alarm advises the user.

The portion of the cables affected is displayed in red. The type, location, time and date of the fault are displayed near the sense cable.

Interface with no faults present

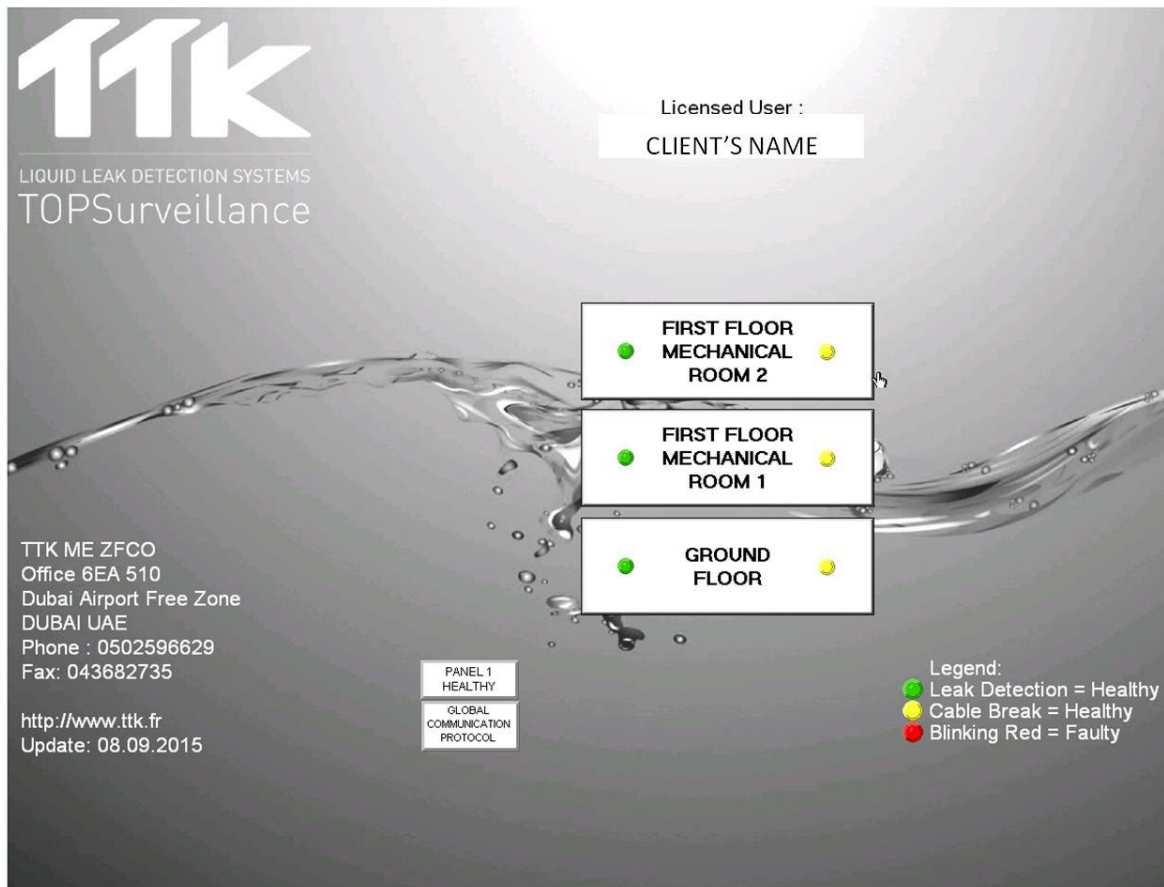

Cable break in first zone (Data Centre)

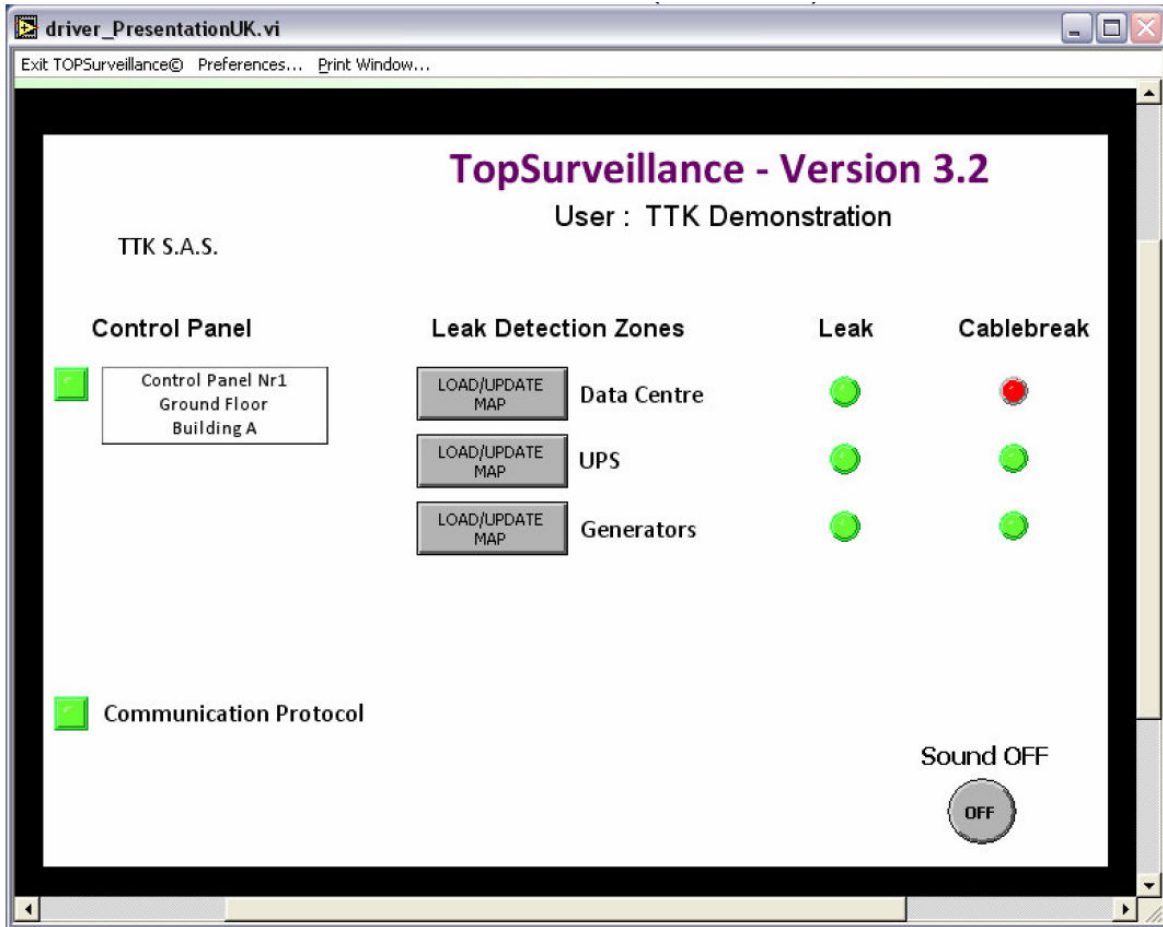

The sound alarm could be cancelled by pressing the button Alarm Sound - OFF appearing on the driver window.

If an alarm disappears, the corresponding red warning light will pass to a normal 'green' status.

The map of each zone can be opened using the corresponding press buttons - Load/Update Map on the driver window. These maps show the actual status of a zone, and the status of each sense cable.

Drawing showing the Cablebreak in Data Hall A

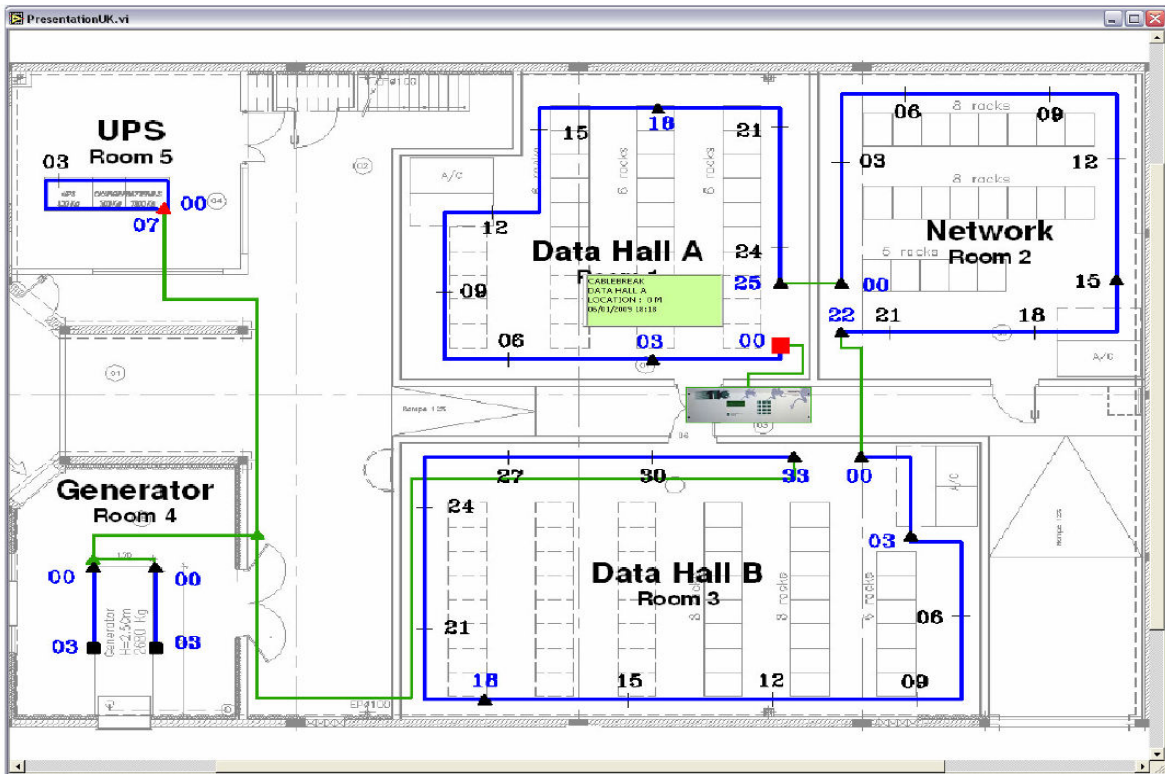

The cables in alarm status are drawn in red and the normal status cables are in blue. A small graphic window appears just next to each sense cable when an alarm is active.

Each window within this software can be printed on a colour printer connected to the computer. Thus a file with different printouts can be conserved by the user in order to follow the overall status of liquid leaks on the site.

CHAPTER IV: EXTERNAL DEVICES

FG-NET was designed from the very beginning for network applications and bring TTK Leak Detection Systems to the new Millennium. The first step was a few functionalities like sending Emails, SNMP Traps, and Modbus over IP. The second step is to add external devices managed by FG-NET through the network.

1. FG-RELAYS

FG-RELAYS is an accessory for FG-NET allowing to add a set of 24 relays to the system. The connection between FG-NET and FG-RELAYS is done through the existing TCP/IP network. Up to 16 FG-RELAYS boxes can be managed by one FG-NET allowing for a maximum of (24x16) 384 additional relays. Those boxes can be installed anywhere on the network as long as they can be reached by FG-NET.

FG-RELAYS IP settings can be done by a web interface. The default IP is 192.168.1.200. The MAC address is EC:46:44:xx:xx:xx (see the serial number for the last 6 characters).

1. IP settings

Connect a computer to FG-RELAYS through an existing network, or make a direct connection with a crossover cable and manual IP set on the computer using those settings:

- Computer IP: 192.168.1.100
- Netmask: 255.255.255.0
- Gateway: 192.168.1.100

Open a web browser (Firefox and Chrome are preferred) and enter the FG-RELAYS default IP in the address bar (192.168.1.200).

FG-RELAYS will prompt for login/password, enter “admin” and “admin”.

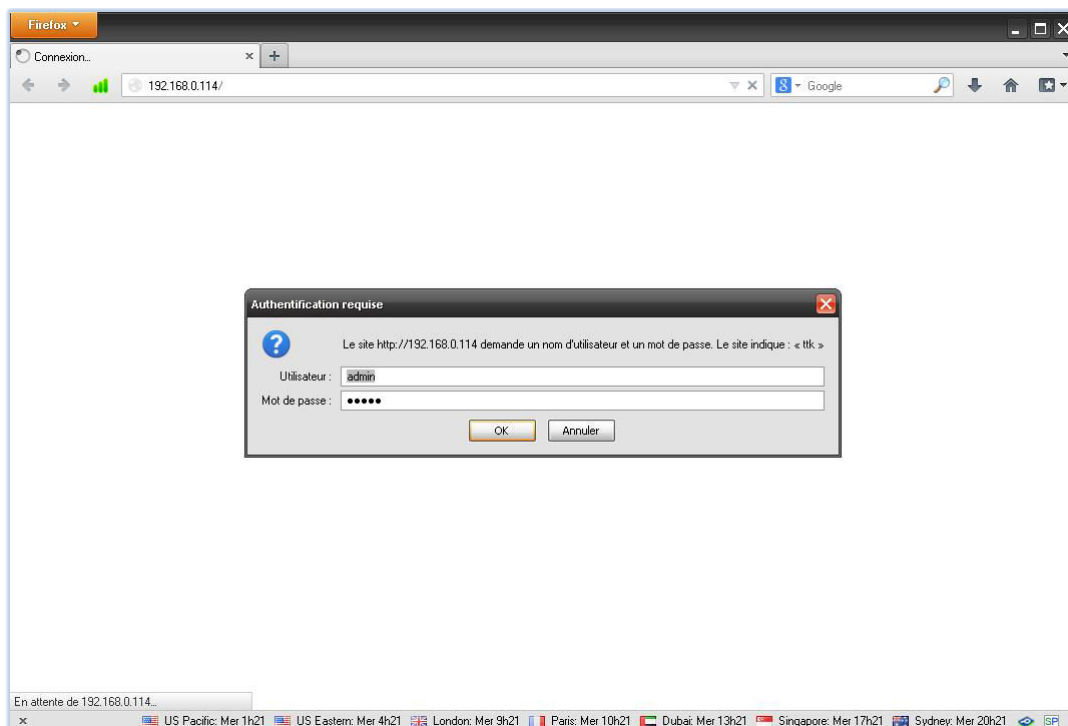

From the web interface, you can change the IP settings according to your needs, change the box name for easier identification, and change the box password.

For detailed information, refer to “FG-RELAYS web interface configuration” document, downloadable from our website, under “Products” > “FG-RELAYS”.

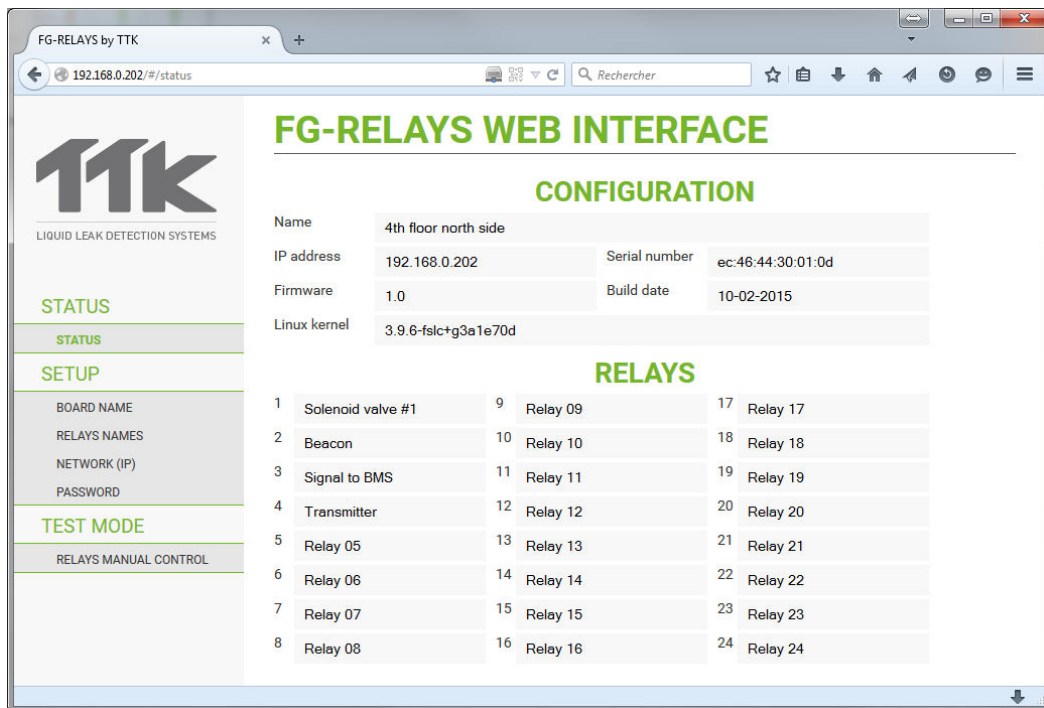

A table will show all 24 relays with the status for each of them.

It is possible to change a relay state by selecting the corresponding number. This is very useful during the system commissioning, or for yearly BMS testing. After a few seconds, FG-NET will override this manual setting and set it back to automatic mode.

2. Pairing with FG-NET

A link must be created between FG-NET and FG-RELAYS. Go to the “Setup” menu of FG-NET under the “FG-RELAYS” tab. Select one available field and enter the FG-RELAYS IP and password. Press the “Connect” button, the FG-RELAYS’s name will appear and the status will change to “online”.

[See Chapter III, paragraph 2.1.5 – “FG-RELAYS” tab](#)

3. Relays settings

The setup of external relays is similar to internal FG-NET relays. Go to the “Cables” menu of FG-NET:

- a. Select a type of fault, Leak or Break
- b. Select the board (cable source): from FG-NET or from a connected FG-RELAYS
- c. Select a relay number, 1 to 8 for local relays, and 1 to 24 for external relays
- d. Press the “Add” button to add the setting in the list
- e. A relay setting can be deleted from the list by touching the Remove icon.

[See Chapter III, paragraph 2.1.3 – Cables tab](#)

2. FG-BBOX

The FG-BBOX is an external device of the FG-NET Digital Unit. It expands FGNET to manage two additional circuits of sense cables. The FG-BBOX is monitored by FG-NET via a standard Ethernet network.

1. IP settings

Connect a computer to FG-BBOX through an existing network, or make a direct connection with a crossover cable and manual IP set on the computer using those settings:

- Computer IP: 192.168.1.100
- Netmask: 255.255.255.0
- Gateway: 192.168.1.1

Open a web browser (Firefox and Chrome are preferred) and enter the FG-BBOX default IP in the address bar (192.168.1.200). The MAC address is EC:46:44:xx:xx:xx (see the serial number for the last 6 characters). FG-BBOX will prompt for login/password, enter “admin” and “admin”.

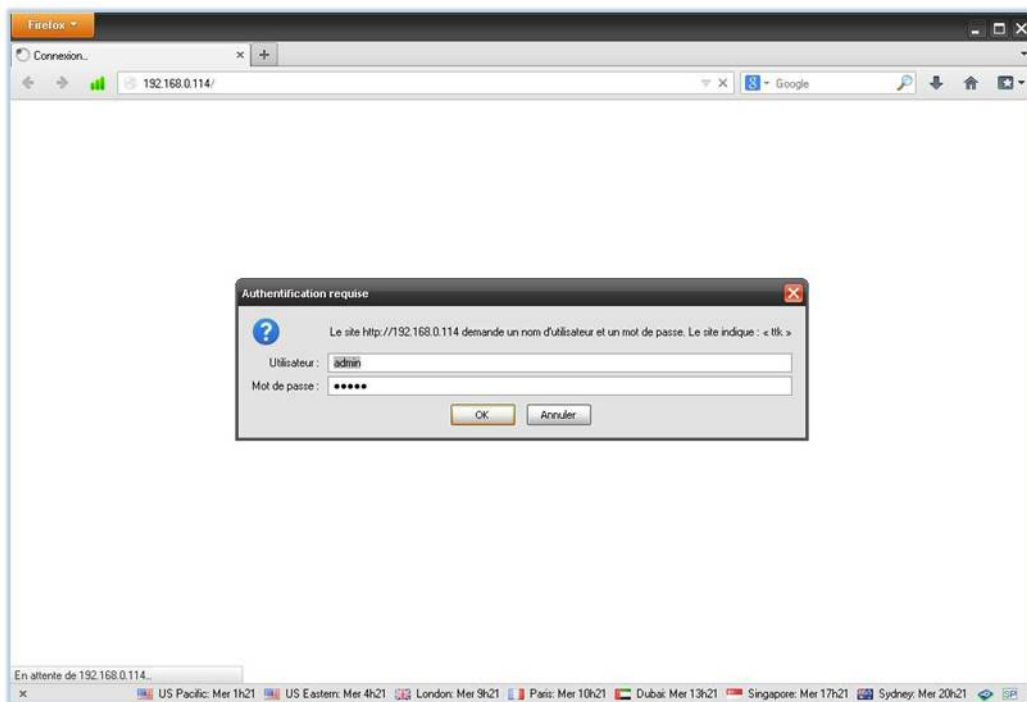

2. Pairing with FG-NET

A link must be created between FG-NET and FG-BBOX. Go to the “Setup” menu of FG-NET, then under the “FG-BBOX” tab, select one available field and enter the FG-BBOX IP and password. Press the “Connect” button, the FG-BBOX’s name will appear and the status will change to “online”.

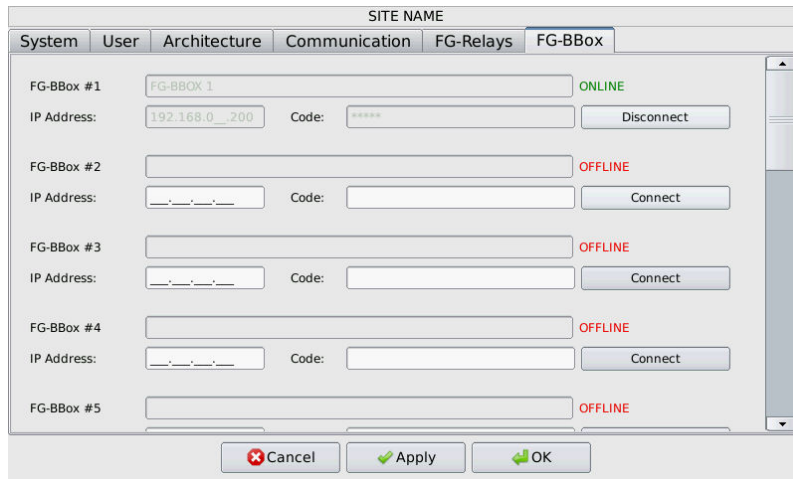

3. FG-BBOX web interface

In the FG-BBOX web interface, 3 main menus are Status, Setup and Test Mode.

The menu "Status" gives a general view of the FG-BBOX's configuration and its real time status: alarms will be displayed on this interface. Data under this menu is generated automatically by the system.

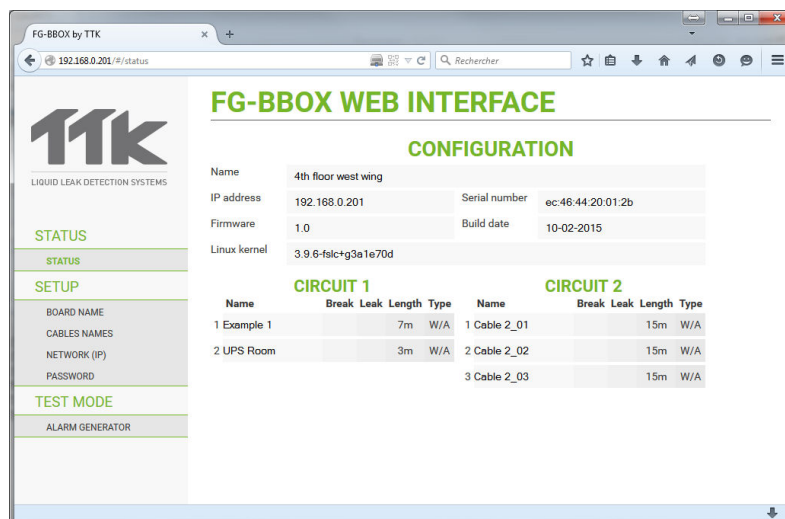

Under "Setup" menu: "Board Name" is the name of the concerning FG-BBOX unit. It can be renamed by the user.

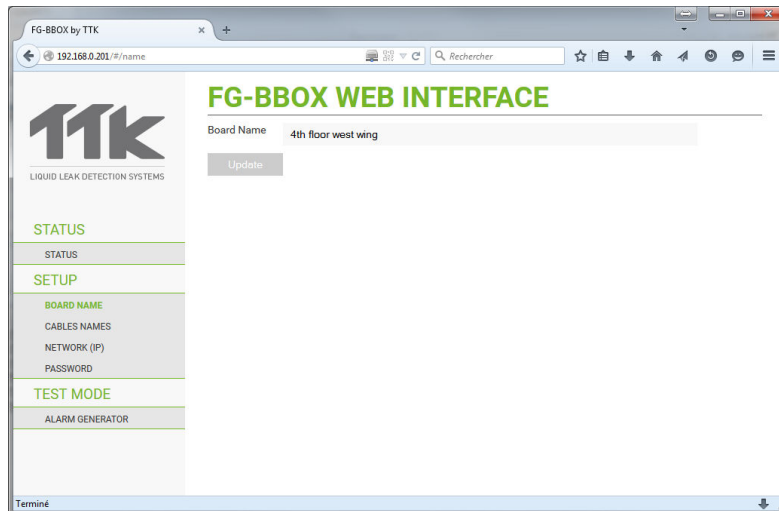

“Setup” > “Cables Names”: all connected cables will be detected automatically by FG-BBOX, their length and type will be displayed (Type: W/A: Water or Acid leak detection sense cable). Each sense cable can be renamed by the user.

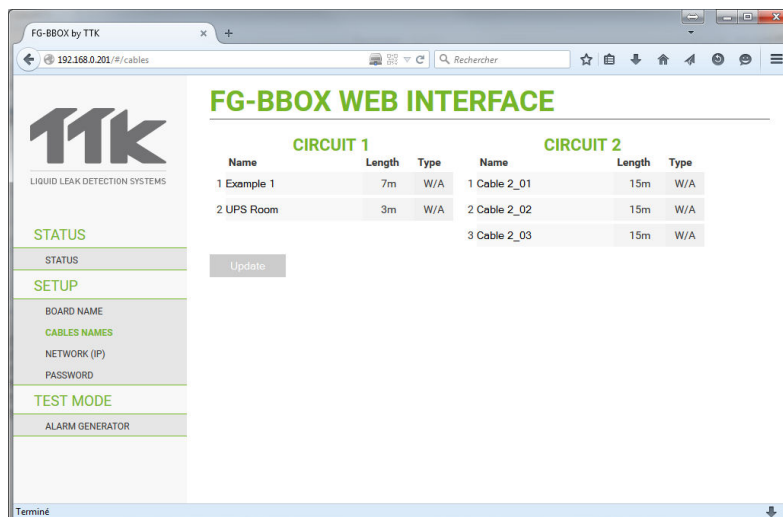

“Setup” > “Network”: Network configuration interface, including IP address, Netmask and Gateway.

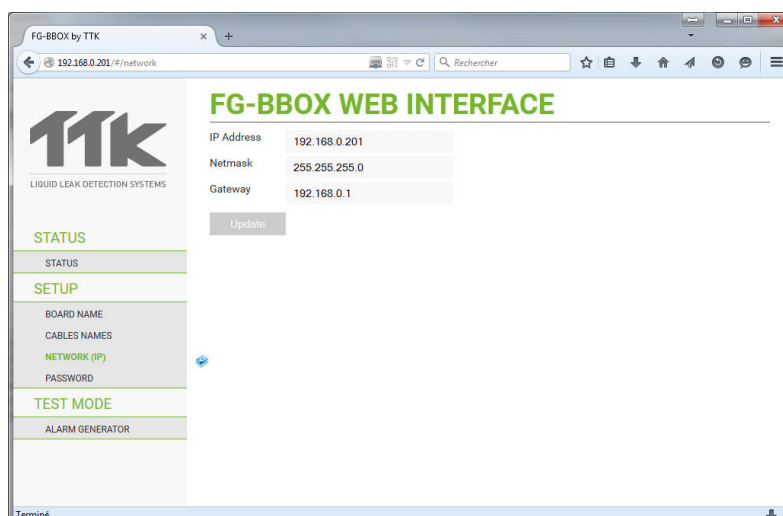

“Setup” > “Password”: the user can modify the default password. The same password will be needed on FG-NET unit in order to connect with the FG-BBOX, for ‘pairing’ function.

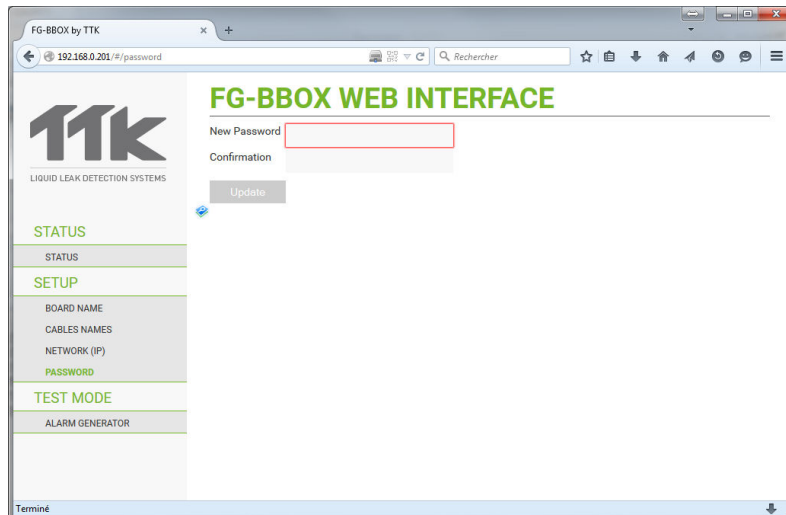

[See Chapter III, paragraph 2.1.5 – “FG-BBOX” tab](#)

For detailed information, refer to “FG-BBOX web interface configuration” document, downloadable from our website.

CHAPTER V: TEST PROCEDURES

All the material has been installed; you have just turned the FG-NET Digital Unit on, it is now necessary to test the system.

1. LEAK TESTS

The Digital Unit is in monitoring mode. Simulate leaks on one cable in order to check the correct operation of the Digital Unit. The precision of the location is ± 1 metre from the leak.

A fault must be present for at least 10 to 20 seconds before being detected by the Digital Unit. The Digital Unit returns to Standby mode 30 seconds after the fault has been dealt with.

Put some tap water on the sense cable, over a length of 12 to 15 cm.

On the Digital Unit, the following alarm page appears. At the same time, an audible alarm is triggered and any relay associated to this fault is activated.



On the above alarm page, the leak location (at 3 m, on cable FNET_1_02, named 'CABLE TEST 1-02'), plus the date and time are displayed.

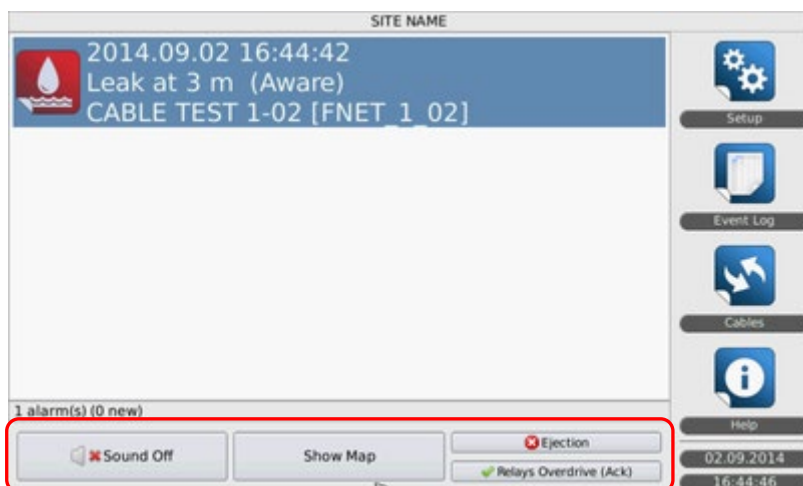

Click on the alarm message, the buttons on the bottom of the screen appear and become available for selecting.

The following buttons are available whatever the type of fault, leak, or break.

- 'Sound off': click to stop the audible alarm.
- 'Show Map': This button will allow you to view the corresponding floor map, if the map is saved in the unit's SD card. If not, a message "map not available!" will appear.
- 'Ejection': clicking on this button will isolate the faulty cable from the system. A password is required to continue the process if this function is protected.
- 'Alarm Ack': means 'alarm acknowledged'. Clicking on this button will force the relay to return to its normal position even if the fault has been dealt with. A password is required to continue the process if this function is protected.

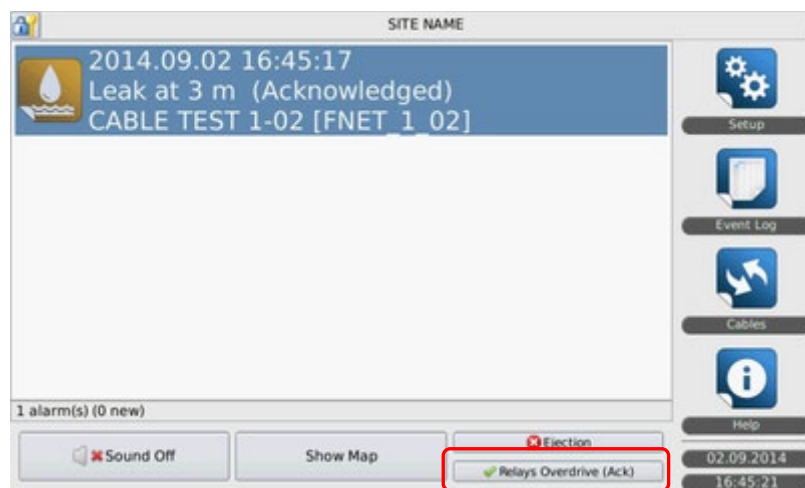

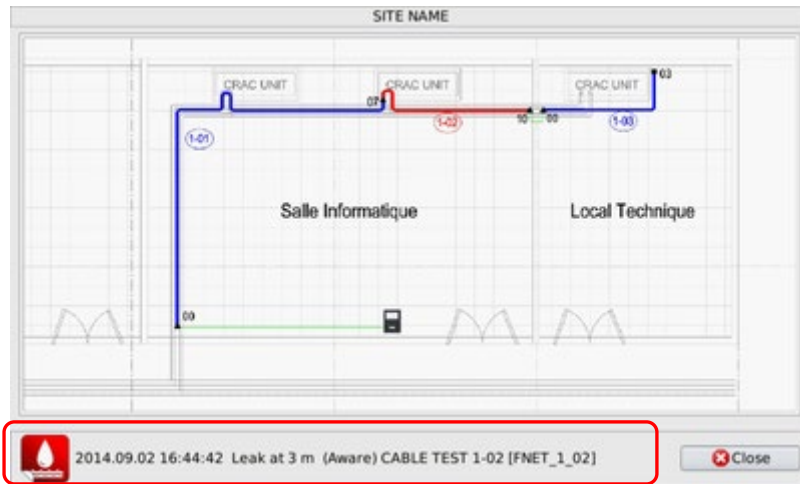

Click on the 'Show Map', and a drawing will appear, highlighting the sense cable on which fault has been detected (in red). The fault information is displayed under the map.

Point to a section on the map to zoom in.

When the fault (in this case a leak) has been dealt with, an alarm message will appear (see below) stating that everything is 'resolved'.

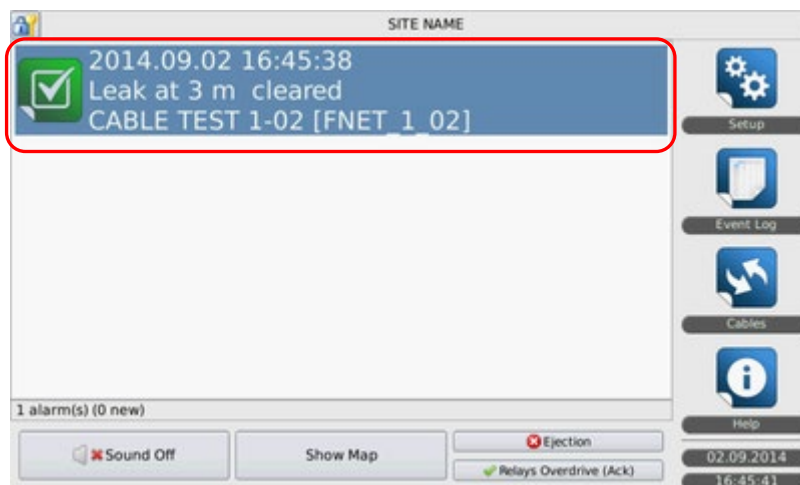

After around 30 seconds, this message will disappear and the user is taken back to the Home screen.

The event log concerning this alarm is saved and can be tracked in the 'Event Log' tab from the Home screen.

2. CABLE BREAK TESTS

The Digital Unit is in Standby mode. Disconnect one of the cables in order to check the correct operation of the Digital Unit.

Remove the sense cable situated at the end of circuit no.1. This will create a cable break.

After approximately 30 seconds an audible alarm is triggered and a cable break message appears. The relay is activated if it is associated to this fault.

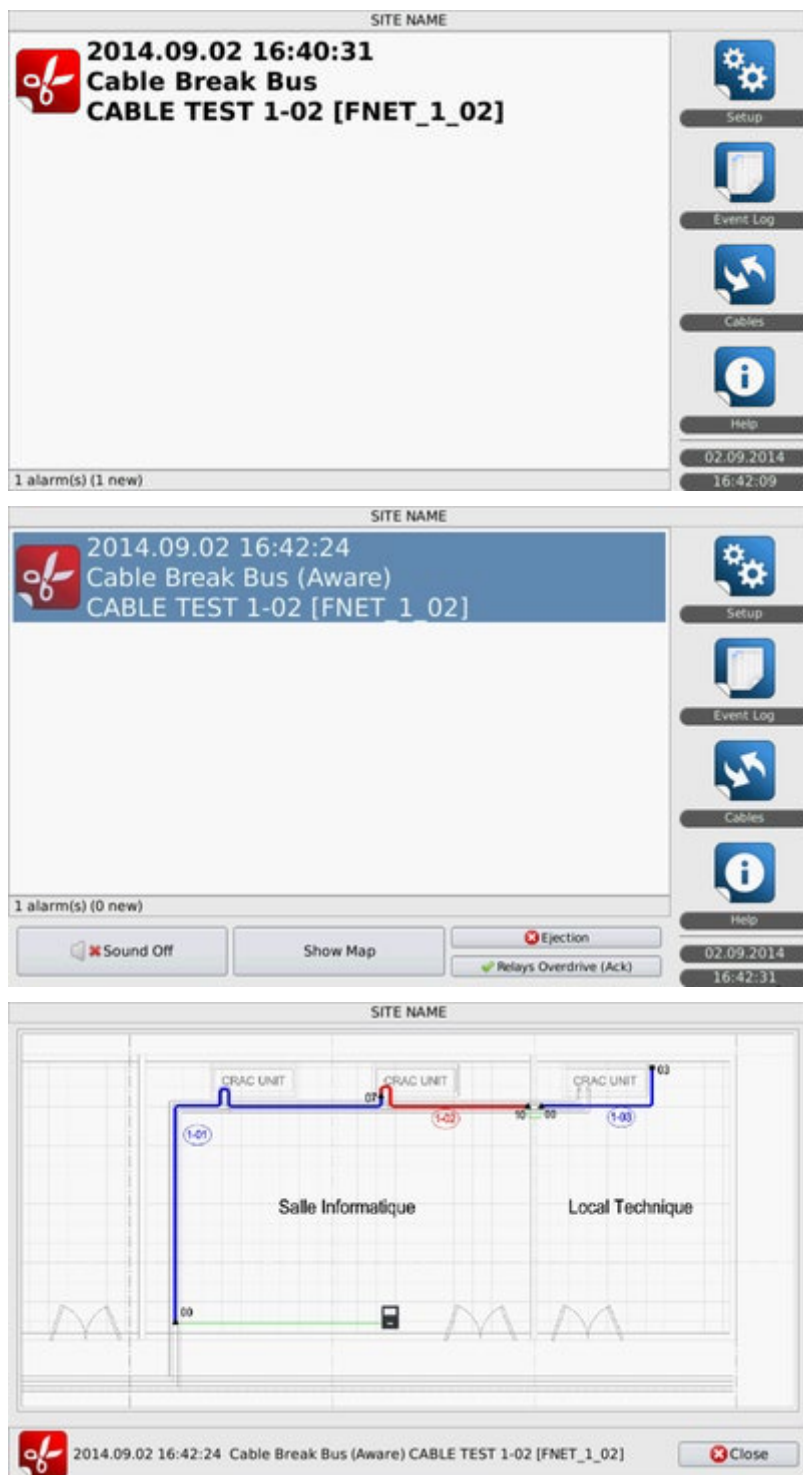

Reconnect the end termination plug, a message indicating the end of the fault appears, the relay is returned back to its initial position and the Digital Unit passes into standby mode.

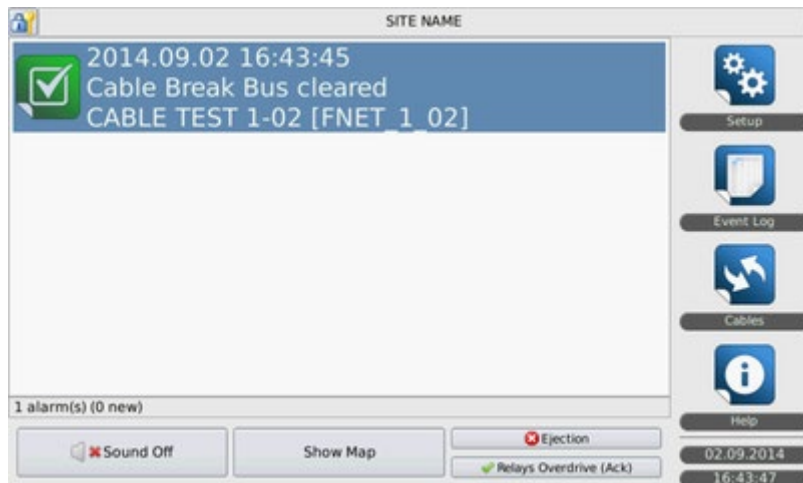

The event log concerning this alarm is saved and can be tracked in the 'Event Log' tab from the Home screen.

3. FG-NET MAP

The FG-NET map is an optional integrated drawing for the FG-NET Digital Unit. It allows the user to view an interactive floor map directly from the Digital Unit touch screen. The maps show the location of all sense cables and their status in real time when in alarm mode.

In standby mode, the maps (per zone) can be viewed from the 'cables' menu:

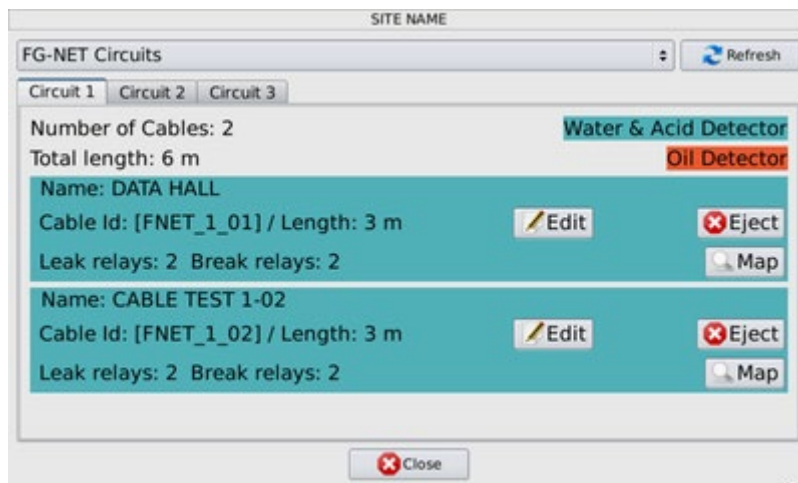

Zone map:

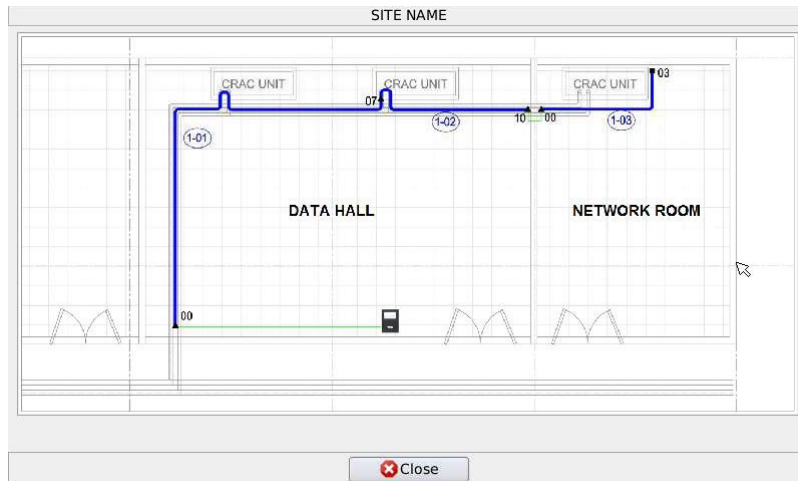

In alarm mode, the map linked to the alarm can be viewed from the alarm screen:

The screenshot shows an alarm screen. At the top, there is a blue header with the following text: '2014.09.02 16:42:24', 'Cable Break Bus (Aware)', and 'CABLE TEST 1-02 [FNET_1_02]'. Below the header, there is a large empty white area. On the right side, there is a vertical menu with icons for 'Setup', 'Event Log', 'Cables', and 'Help'. At the bottom left, there is a status bar that says '1 alarm(s) (0 new)'. Below this, there are several buttons: 'Sound Off' (with a speaker icon), 'Show Map' (highlighted with a red box), 'Ejection' (with a red 'X' icon), and 'Relays Overdrive (Ack)' (with a green checkmark icon). At the bottom right, there is a date and time display: '02.09.2014 16:42:31'.

Alarm map:

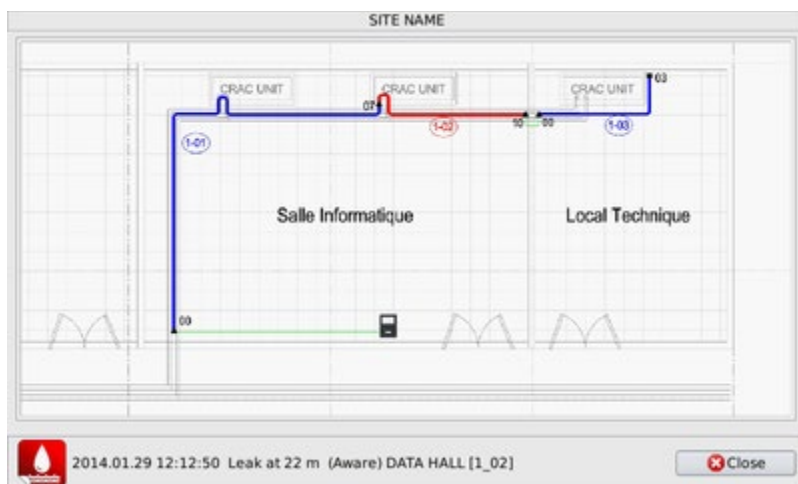

Whatever the type of map, it is possible to point to and zoom in on the screen.

CHAPTER VI: MAINTENANCE – FAULT FINDING

1. CHECKING THE SYSTEM



It is highly recommended to carry out complete maintenance of the system every 6 months. Maintenance procedures are established by TTK or its authorized distributors according to the specificity of the installations.

These tests make it possible to check the state of the circuits, with the sense cables, and to control the correct operation of the FG-NET Digital Unit; this will ensure a better operation and time reliability for the system. These tests can be carried out more frequently in particularly exposed zones.

- To carry out simulations for leaks and cable breaks, refer to the test procedures (chapter IV):
- Check the position of the sense cables and their plating on the earth
- Check the state of the hold-down clips and their fixings
- Check the connection of the cables on the FG-NET Digital Unit
- Check the presence of the tags on the unit's cables
- Check the exact time and date

A report/ratio of maintenance must be written after each maintenance check. TTK UK Ltd., TTK Asia Ltd and TTK Pte Ltd offer a preventive maintenance contract comprising of two annual visits to each of its customers.

2. SYSTEM MAINTENANCE



Caution: For any handling of the central processing unit, it is imperative to power the FG-NET Digital Unit down. (Turn it off)

2.1. Replacing a sense cable



Use only parts supplied by TTK or its authorized distributors. The compatible parts to be used with FG-NET are sensing cables FG-EC and FG-AC.

The replacement of a sense cable is an easy and fast operation. Disconnect the two ends from the cable and replace it with the new cable.

A sense cable must be replaced if it is sheared or has been severely contaminated.

The traces of contamination in weak concentration on a small surface can be cleaned off.

Before replacing a sense cable, it is necessary to turn the central unit off.

2.2. Precautions for use and storage

The sense cable is mechanically resistant but remains a sensitive cable; it is necessary to respect the following procedures:

- Keep the sense cables in their original condition in a clean and dry place.
- The installations of the sense cables must be carried out after all other works on the building site are finished.
- Protect the sense cables against any risk from shearing (falls of heavy and cutting tools), any contact with heat sources or flames (welding, gas-fired warm air heater...), any contact with contaminant liquids (painting, detergent, cement...)
- During the fixing of the clips on the earth, do not use adhesive bands; they absorb moisture and can set off alarms.
- Cleaning of the electronic panel: FG-NET unit can be cleaned using a slightly damp tissue.



Do not pour water or other liquids on the panel! Keep the panel closed and out of the reach of non authorized staff!

2.3. Adding sense cables to an existing circuit



Use only parts supplied by TTK or its authorized distributors. The compatible parts to be used with FG-NET are sensing cables FG-EC and FG-AC.

An extension of the FG-NET Digital Unit implies either an addition of sense cables to a circuit of existing cables (maximum capacity of 40 sense cables per circuit,) or the installation of a new circuit of cables (see 3.4). If you want to move sense cables, proceed in the same way.

- Turn the Digital Unit off;
- Add or move the sense cables;
- Turn the Digital Unit on
- Check and modify the denomination of the cables in the 'Cables' menu
- Follow the test procedures

2.4. Addition of a New Circuit of Sense Cables (Circuits no.2 and/or no.3)

If the maximum capacity of the existing circuit is reached (40 sense cables), it is necessary to install a circuit of additional cables. This requires the addition of a connecting cable for the circuit.

When circuit no.2 is in use:

- Remove the existing shunt between 2A and 2B.

When circuit no.3 is in use:

- Remove the existing shunt between 3A and 3B.



A shunt between items 1 and 2 causes a dysfunction of the digital unit.

- Turn the Digital Unit on
- Use the 'Cables' menu to name the cables
- Follow the test procedures

2.5. Removal of the system

If for any reason the system shall be removed from the site, it shall be done according to the laws applicable in the country where installed.



This panel contains soldered, non-replaceable and not serviceable lithium battery. Please dispose properly after removal, refer to the applicable laws in the country of installation and use!

3. TROUBLE SHOOTING GUIDE

No maps are displayed:

By default, the maps are saved in the SD card. If the maps are not displayed, check that the 'map licenses' field appears in the 'System' tab in the 'Setup' menu. Once it is unlocked, this field should disappear. [See Chapter III, Paragraph 2.1.1 – Map Licenses](#)

Check if the SD card is correctly inserted into the FG-NET panel; then check if the drawings are present in the SD card, under the 'map' file.

- alarm-FNET_1_01.png
- zone- FNET_1_01.png
- alarm- FNET_1_02.png
- ...

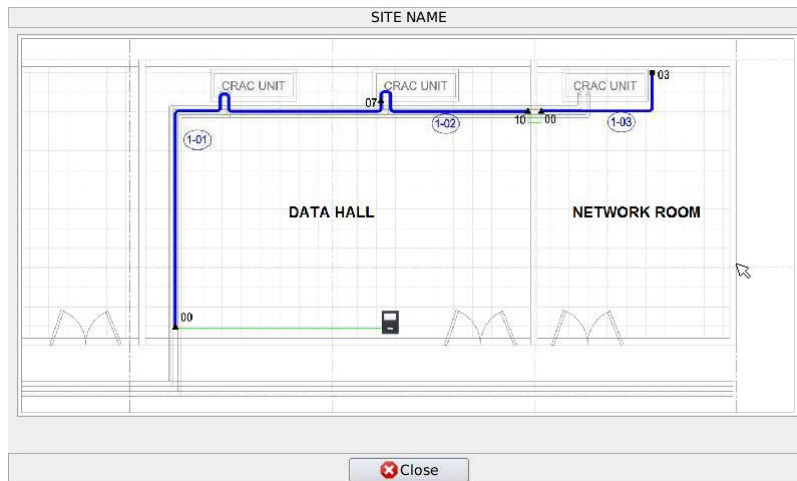
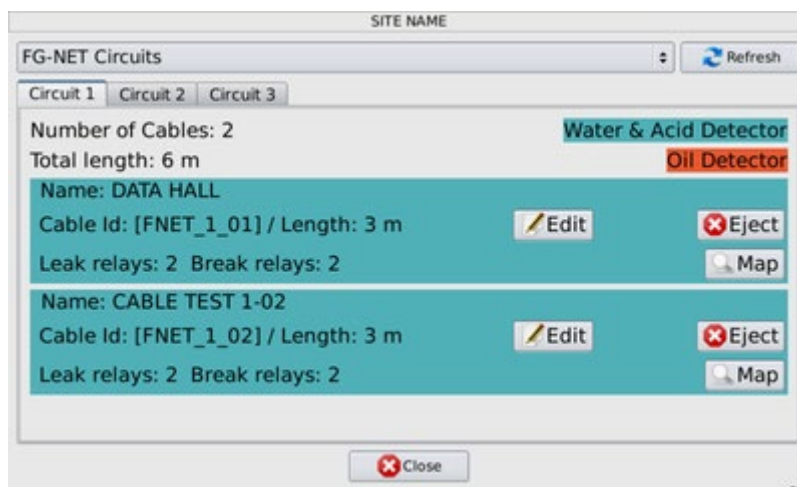

The password is not functioning:

Contact the administrator to check the access rights - It is normal that the user cannot enter the 'setup' menu, only admin have access rights to this menu.

In case of you lost the password, contact the installer to provide you a temporary password.

In case of a fault (leak or cable break), I can see the alarm message on the panel screen, but why can I not hear the sound of the alarm?

In the case of a fault, the FG-NET panel activates a sound alarm and displays the alarm message. If you cannot hear the sound, firstly, check if a 'sound off' icon appears on the left top of the Home screen; if not, then check in the 'setup' menu, 'system' tab, and click on the 'sound ON/OFF' to change the status.

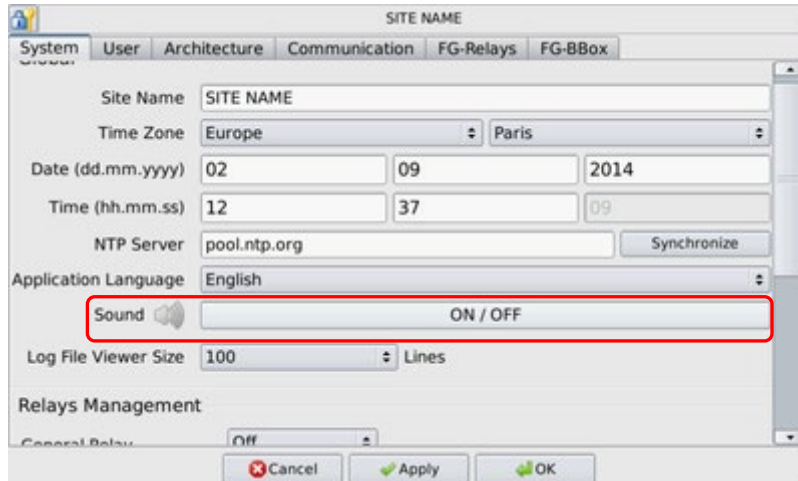

A leak alarm is not activated immediately:

In the case where the leak alarm is only activated several minutes after the LED on the sense cable turns to red, this may be caused by the setup of the 'time' function in the FG-NET unit.

Check in menu 'Cables'— 'Edit' button (ref below image), configure the time to '0' seconds, click 'apply'. Then carry out a leak test on the same sense cable.

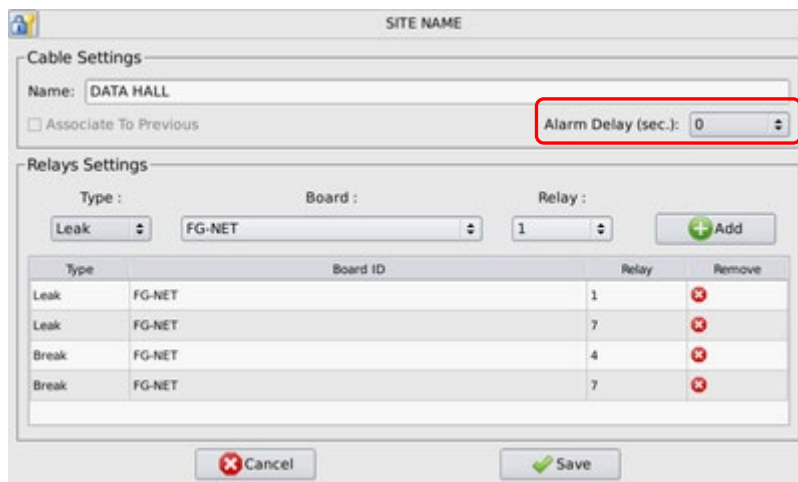

A leak alarm is not activated after 5 minutes:

In the case where the leak alarm does not activate after a leak, whereas the LED on the sense cable turns to red, it means the leak has been detected by the sense cable. This may be caused by the setup of the 'ejection' function in the FG-NET unit. Check on the Home screen if ejection message has appeared and is flashing red and white (see below). If so, click on the message and reactivate the sense cable. The ejection message should disappear from the Home screen. Then carry out a leak test on this sense cable.

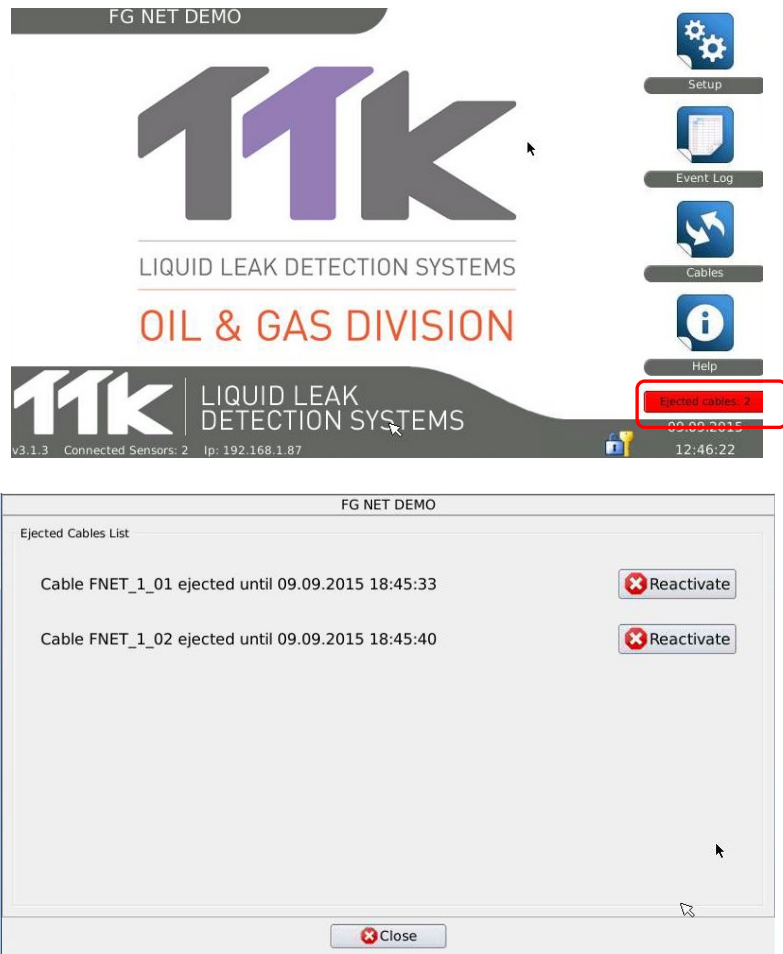

A Leak is detected but badly localised:

The precision of the localization of a leak is + / - 1 metre. If a leak is not visible in this perimeter, pay close attention to the whole length of the cables. The leak cannot be on the cable upstream, or on the cable downstream; each cable is managed in an autonomous way via a chip, placed in its connector on the female end.

The installed sense cables are not being read when powered on:

Check the connection of the FG-CLC cable to the connector block of the Digital Unit. An inversion between the two couples red + black and green + white damages the electronics of the first connected sense cable.

Leak message which appears and disappears intermittently:

The leak message does not remain permanently displayed. The threshold of contamination of the sense cable is not reached. Either there is a small leak (insufficient to set off the alarm), or the cable is polluted (dirt, paint, grease, bitumen...).

The relays are not functioning:

In the case of the fault (leak or cable break), the FG-NET panel activates the associated relay(s). If the relay is not activated, check the 'configuration' > 'system' menu for the general relay; and 'cables' menu for specific relays.

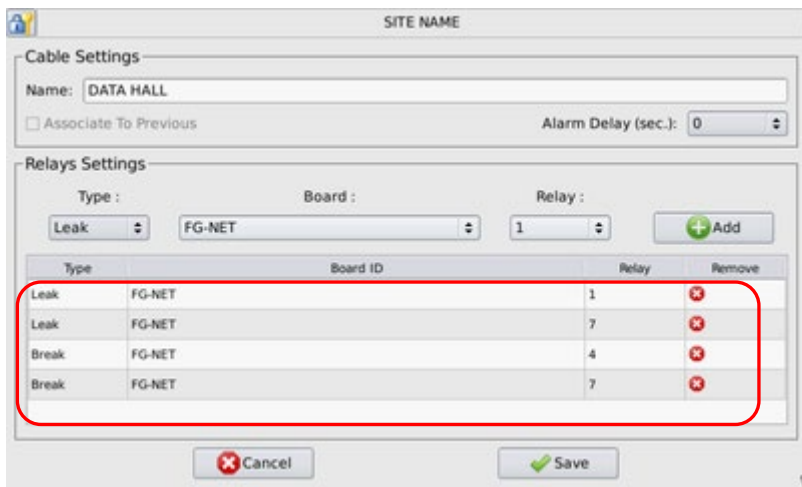
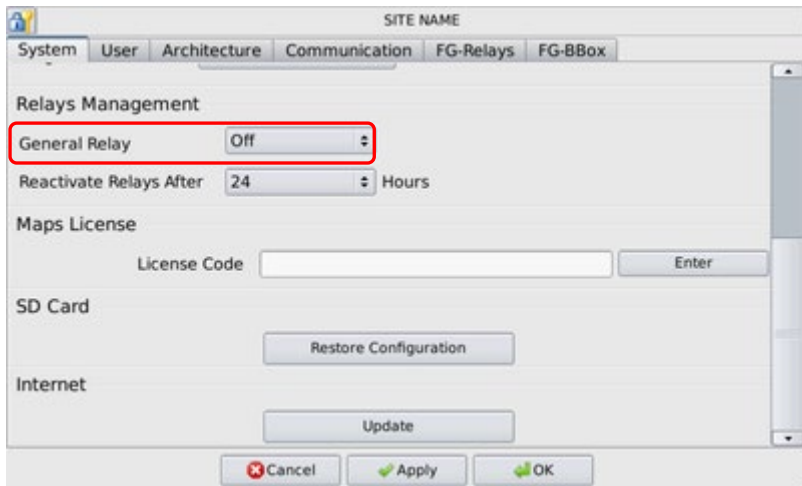

Emails / SNMP sent by the panel are not received:

The FG-NET panel can send emails or SNMP messages if the setup is correctly performed. Check the network and e-mail/SNMP parameters in the 'communication' tab.

Display problems:

If the back-lighting is flashing, this means a new alarm has been detected.

Select the alarm to stop the flashing.

For all other problems, please contact TTK UK Ltd., TTK Asia Ltd., or TTK S.A.S.

Appendix

1. Digital Unit connection diagram and ratings: FG-NET E / F

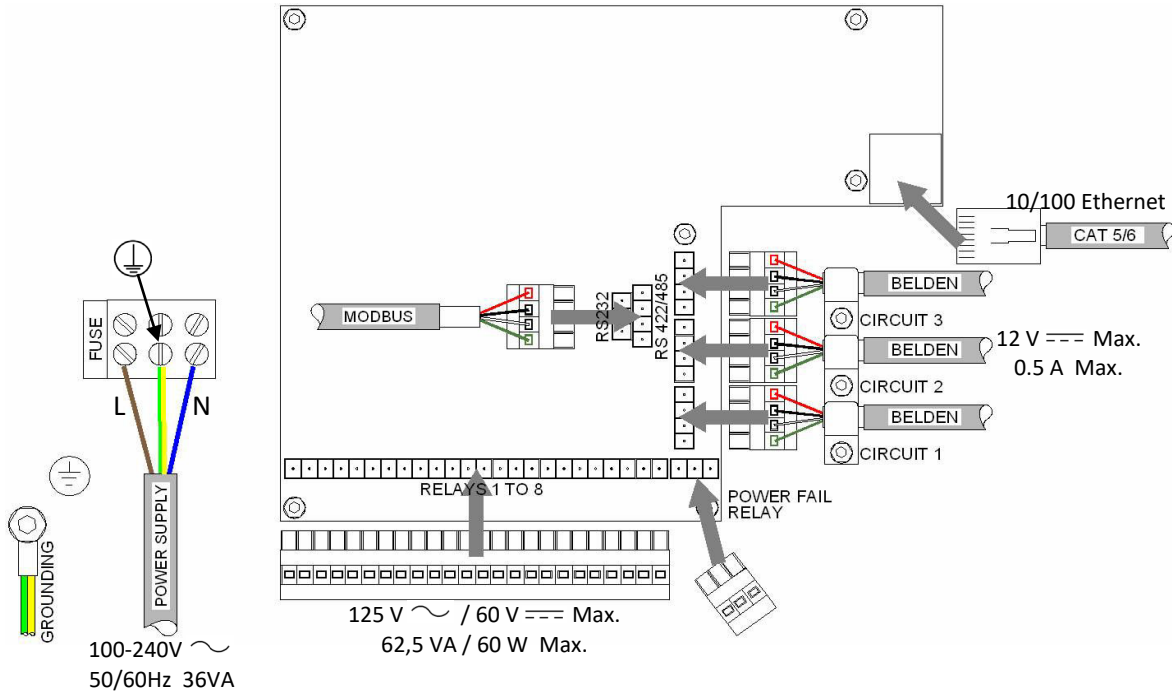

2. Modbus Table

Project :
Subject:BMS integration points with Leak Detection system

PANEL TYPE : FG-NET
Location :
IP Address : XXX.XXX.XXX.XXX
PROTOCOL : MODBUS TCP port 502
and/or Serial MODBUS RTU, use ONE SERIAL INTERFACE ONLY, RS232 OR RS422 OR RS485
RS 232: Use 3 points terminal and crossover cable
RS 422: Use 4 points terminal and crossover cable
RS 485: Use 4 points terminal and loop Rx- with Tx- for DATA-, and Rx+ with Tx+ for DATA+

BAUDRATE : 9600 (can't be changed)
PARITY : NO (can't be changed)
STOP BIT : 1 BIT STOP, 8 DATA BITS (can't be changed)
SLAVE NUMBER can be set from 1 to 247

CABLE NUMBER	DESCRIPTION	CABLE NAME SET ON PANEL	DEVICE ID (SLAVE NO)	TYPE INFORMATION				STATE INFORMATION				LOCATION (m)		REMARKS		
				TYPE REGISTER ADDRESS	TYPE BIT POSITION			STATE REGISTER ADDRESS	STATE BIT POSITION			LOCATION REGISTER ADDRESS	LOCATION BIT POSITION LOCATION (m)			
					LEAK	CABLE BREAK BUS	CABLE BREAK SENSOR		CABLE BREAK END PLUG	NEW	SEEN				ACKED	EJECTED
CIRCUIT 1 (up to 40 cables from 1_01 to 1_40)																
1_01	CABLE 1_01		1	7101	bit 4	bit 0-7	bit 1-7	N/A	8101	bit 0	bit 1	bit 2	bit 3	9101	bit 0 to 15	
1_02	CABLE 1_02		1	7102	bit 4	bit 0-7	bit 1-7	N/A	8102	bit 0	bit 1	bit 2	bit 3	9102	bit 0 to 15	
1_03	CABLE 1_03		1	7103	bit 4	bit 0-7	bit 1-7	N/A	8103	bit 0	bit 1	bit 2	bit 3	9103	bit 0 to 15	
1_04	CABLE 1_04		1	7104	bit 4	bit 0-7	bit 1-7	N/A	8104	bit 0	bit 1	bit 2	bit 3	9104	bit 0 to 15	
1_05	CABLE 1_05		1	7105	bit 4	bit 0-7	bit 1-7	N/A	8105	bit 0	bit 1	bit 2	bit 3	9105	bit 0 to 15	
1_06	CABLE 1_06		1	7106	bit 4	bit 0-7	bit 1-7	N/A	8106	bit 0	bit 1	bit 2	bit 3	9106	bit 0 to 15	
1_07	End Plug		1	7107	N/A	N/A	N/A	bit 2-7	8107	bit 0	bit 1	bit 2	bit 3	9107	N/A	Will code Break End of Circuit fault only
CIRCUIT 2 (up to 40 cables from 2_01 to 2_40)																
2_01	CABLE 2_01		1	7201	bit 4	bit 0-7	bit 1-7	N/A	8201	bit 0	bit 1	bit 2	bit 3	9201	bit 0 to 15	
2_02	CABLE 2_02		1	7202	bit 4	bit 0-7	bit 1-7	N/A	8202	bit 0	bit 1	bit 2	bit 3	9202	bit 0 to 15	
2_03	CABLE 2_03		1	7203	bit 4	bit 0-7	bit 1-7	N/A	8203	bit 0	bit 1	bit 2	bit 3	9203	bit 0 to 15	
2_04	CABLE 2_04		1	7204	bit 4	bit 0-7	bit 1-7	N/A	8204	bit 0	bit 1	bit 2	bit 3	9204	bit 0 to 15	
2_05	CABLE 2_05		1	7205	bit 4	bit 0-7	bit 1-7	N/A	8205	bit 0	bit 1	bit 2	bit 3	9205	bit 0 to 15	
2_06	End Plug		1	7206	N/A	N/A	N/A	bit 2-7	8206	bit 0	bit 1	bit 2	bit 3	9206	N/A	Will code Break End of Circuit fault only
CIRCUIT 3 (up to 40 cables from 3_01 to 3_40)																
3_01	CABLE 3_01		1	7301	bit 4	bit 0-7	bit 1-7	N/A	8301	bit 0	bit 1	bit 2	bit 3	9301	bit 0 to 15	
3_02	CABLE 3_02		1	7302	bit 4	bit 0-7	bit 1-7	N/A	8302	bit 0	bit 1	bit 2	bit 3	9302	bit 0 to 15	
3_03	End plug		1	7303	N/A	N/A	N/A	bit 2-7	8303	bit 0	bit 1	bit 2	bit 3	9303	N/A	Will code Break End of Circuit fault only

CABLE INFORMATION	
TYPE:	Types can be Leaks, or Cable Break Bus (communication loss), or Cable Break Sensor (only the sensing part), or Cable Break End of Circuit (missing end plug), bit 7 is a common fault for these three Cable Breaks, show this register in Binary.
STATE:	States can be New, or Seen, or Acknowledged, or Ejected, when a cable is ejected, the TYPE and LOCATION Registers won't code alarms anymore, show this register in Binary.
LOCATION:	Locations are given in meters, the system will return a 0 value when there is no alarm, associations will affect this value and the location is always given as per the panel display (I.E. 587 meters), show this register in Decimal.
CHECK SECOND SHEET FOR BITS LAYOUT	
ADDITIONAL REGISTERS	
4096 FOR SYSTEM GLOBAL STATUS,	this will show if there is any Leak or Cable Break anywhere on the Panel
4097 FOR CIRCUIT 1 GLOBAL STATUS,	this will show if there is any Leak or Cable Break anywhere on Panel 1
4098 FOR CIRCUIT 2 GLOBAL STATUS,	this will show if there is any Leak or Cable Break anywhere on Panel 2
4099 FOR CIRCUIT 3 GLOBAL STATUS,	this will show if there is any Leak or Cable Break anywhere on Panel 3
CHECK SECOND SHEET FOR BITS LAYOUT	

3. Commissioning guide

Commissioning Record (Company Owning or Operating Facility):



FG-NET Digital Leak Detection System

1. Installation Parameters

<ol style="list-style-type: none"> 1. FG-NET Digital Unit Tests <ul style="list-style-type: none"> ✓ Functionalities ✓ Configurations 2. Circuit(s) of Sense Cables <ul style="list-style-type: none"> ✓ Architecture ✓ Fixed by Hold Down Clips ✓ Signal Tags 3. Drip Trays: Y/N 4. Leak Simulations 5. Cable Break Simulations 6. Operation 7. Drawing and Users Documents 8. Comments <p style="text-align: right; margin-top: 20px;">Date of Commissioning:</p>	<p>Client:</p> <p>Address: Contact: Tel.: Order N°:</p> <p>TTK Ltd. Address:</p> <p>Contact: Tel.:</p> <p>FG-NET Digital Unit Fixed</p> <ul style="list-style-type: none"> ✓ Serial N°: ✓ Wall or rack Mounted: F or E ✓ Circuits installed: 1, 2 & 3 ✓ Drawings: Yes or No <p>Circuit(s) of Sense Cables:</p> <ul style="list-style-type: none"> ✓ Circuits: N°1: N°2: N°3: ✓ Type of Sense Cables: ✓ Total Lengths Installed: <ul style="list-style-type: none"> ✓ Circuit N°1: _____ meters ✓ Circuit N°2: _____ meters ✓ Circuit N°3: _____ meters <p>Date of Installation:</p>
--	---

Commissioning Record (Company Owning or Operating Facility):



FG-NET Digital Leak Detection System

2. FG-NET Digital Unit Tests

3. Circuit(s) of Sense Cables

<p>Functionalities: (Enter in menu "cables" to load the cable list)</p> <ul style="list-style-type: none"> ✓ Lengths of sense cable display per circuits <p>Configurations : (Enter in menu "setup" to view the configuration)</p> <ul style="list-style-type: none"> ✓ System Parameters: <ul style="list-style-type: none"> ✓ Date, time ✓ Admin password by default: admin ✓ Installation parameters: <ul style="list-style-type: none"> ✓ Cable names ✓ Sense cables associated: (Y/N) per Room ✓ Exploitation parameters: <ul style="list-style-type: none"> ✓ General relays, leak & cablebreak relays ✓ JBUS/Modbus RS232, RS422/485 <p>Event log: (Enter in menu " event log" load the historical with the last faults)</p> <p>Comments: Tests OK (Y/N)</p>	<p>Sense Cables Installed:</p> <ul style="list-style-type: none"> ✓ Type: FG-EC, FG-ECS, FG-AC, FG-ACS, FG-HC2 <p>List of technical rooms Protected:</p> <ul style="list-style-type: none"> ✓ Circuit N°1, --- metres of sense cable <ul style="list-style-type: none"> ▪ Room 1: --- m (---FG-EC15 & ---FG-EC7) ▪ Room 2: --- m (---FG-EC15 & ---FG-EC7) ▪ Room 3: --- m (---FG-EC15 & ---FG-EC7) ▪ Room 4: --- m (---FG-EC15 & ---FG-EC7) ✓ Circuit N°2, --- metres <ul style="list-style-type: none"> ▪ Room 1: --- m (---FG-EC15 & ---FG-EC7) ▪ Room 2: --- m (---FG-EC15 & ---FG-EC7) ▪ Room 3: --- m (---FG-EC15 & ---FG-EC7) ▪ Room 4: --- m (---FG-EC15 & ---FG-EC7) ✓ Circuit N°3, --- metres <ul style="list-style-type: none"> ▪ Room 1: --- m (---FG-EC15 & ---FG-EC7) ▪ Room 2: --- m (---FG-EC15 & ---FG-EC7) ▪ Room 3: --- m (---FG-EC15 & ---FG-EC7) ▪ Room 4: --- m (---FG-EC15 & ---FG-EC7) <p>Hold down Clips fixed: (Y/N)</p> <p>Signal Tags: fixed (Y/N)</p> <p>Comments: Tests OK (Y/N)</p>
--	--



FG-NET Digital Leak Detection System

4. Drip Trays: (Y/N)

Architecture:
(Zones covered in High Level)

- ✓ Room 1
- ✓ Corridor
- ✓ Room 2
- ✓ Room 3
- ✓ Room 4

Installation:

- ✓ Drip Trays

Comments: Tests OK (Y/N)



FG-NET Digital Leak Detection System

5. Leak Simulations

6. Cable Break Simulations

Leak Simulations:
(Put tap water on the sense cable, over a length of 12 to 15 cm)

- ✓ Red LED activates on cable connector
- ✓ FG-NET Digital Unit actives
- ✓ Alarm sounds
- ✓ Display (location, date and time)
- ✓ Drawing (if installed) show faulty cable in red
- ✓ Dry Contact(s) actives

Dry the water on a point of sense cable

- ✓ Green LED activates on cable connector
- ✓ FG-NET Digital Unit actives
- ✓ Dry Contact(s) back to normal

Simulate leaks on different points of sense cables: All the four areas in high and low levels with relays activated

Comments: Tests OK (Y/N)

Cable Break Simulations:
(Plug OUT the first sense cable)

- ✓ LED off on cable connector
- ✓ FG-NET Digital Unit actives
- ✓ Alarm sounds, acknowledge
- ✓ Display and checking with drawing
- ✓ Dry Contact(s) actives

(Plug IN the first sense cable)

- ✓ Green LED on on cable connector
- ✓ FG-NET Digital Unit actives :
- ✓ LED ignites back:
- ✓ Dry Contact(s) back to normal

Simulate cable breaks on different points of sense cables: Battery Room in high level

Comments: Tests OK (Y/N)

FG-NET Digital Leak Detection System

7. Operation

8. Drawings and Users Documents

<p>Dry Contacts Configuration:</p> <ul style="list-style-type: none"> ✓ Quantity of dry contacts used: --- ✓ Leak and Cable Break contacts ✓ NC/NO <p>Relays used:</p> <ul style="list-style-type: none"> ✓ R1: ✓ R2: ✓ R3: ✓ R4: ✓ R5: ✓ R6: ✓ R7: ✓ R8: ✓ R9: (General) <p>Comments: Acceptance Tests (Y/N)</p>	<p>Drawing(s) of Installation: (Y/N)</p> <ul style="list-style-type: none"> <input type="checkbox"/> Quantity: <input type="checkbox"/> Integrated or Laminated <p>Technical Users Documents</p> <ul style="list-style-type: none"> <input type="checkbox"/> Technical Data sheets: (Y/N) <input type="checkbox"/> Operation Guide: (Y/N) <input type="checkbox"/> Maintenance Contract: (Y/N) <input type="checkbox"/> List of spare parts: (Y/N) <p>Comments:</p>
--	--



FG-NET Digital Leak Detection System

9. General Comments

<p>Date of Commissioning:</p>
<p>Client Acceptance:</p> <ul style="list-style-type: none"> ✓ Name: OK ✓ Signature: ✓ Date:
<p>TTK Ltd. : Test performed by:</p> <ul style="list-style-type: none"> ✓ Name: ✓ Signature: ✓ Date:
<p>Copies to: 1. Client 2. TTK Ltd.</p>
<p>2011 – Commissioning Report TTK SAS.</p>

