



LIQUID LEAK DETECTION SYSTEMS

FG-SYS DIGITAL UNIT

OPERATION & INSTALLATION GUIDE



DESCRIPTION

The FG-SYS Digital system ensures an immediate detection and a precise localization of conductive liquid leak (water, acids and bases) in industrial applications and buildings.

The system is composed of a FG-SYS Digital Unit, lengths of sense cables and accessories.

The FG-SYS Digital Unit is designed to be used with sense cables FG-EC/FG-ECS (Water and Bases) and FG-AC/FG-ACS (Acids). The presence of a liquid on the sense cable starts an audible alarm, as well as a luminous alert. The information of the fault is displayed on the LCD screen, which specifies the localization of the initial leak point to the nearest meter. FG-SYS Digital Unit is **not** compatible with hydrocarbon FG-OD sense cables and probes.

Each sense cable is equipped with a microchip at female connector end. The digital unit questions successively each cable; the microchip then transmits numerically 'the state' of the cable to the digital unit. Because of autonomy of each cable, several faults can be detected at the same time (but only one fault per cable).

A digital unit can manage three circuits of sense cables; each one of these circuits has a maximum capacity of 40 sense cables of 15 meters, or 600 meters maximum per circuit. In addition to the presence of a liquid, the system detects and locates any fault of cable break on the circuit of cables.

The FG-SYS Digital Unit is available in wall mounted version (FG-SYS F), with a metal enclosure.

The keyboard (of thirteen buttons) on the front face makes it possible to configure the system: Nominate the zones for detection (by allotting a name to each sense cable), choose and configure for the set-up (relays, serial communication), setting the parameters of the system (language, adjustment of the time, date, protection code).

The green luminous witness, or red, indicates the state of the digital unit under surveillance mode or alarm. The button on the right (ECS) allows the manual acknowledgement of the sound alarm, the validation of an operation, and the return to the previous screen. The last thirty defects are kept in memory and their description is accessible in the historical menu.

FG-SYS also has a general test function. The Digital Unit indicates the number of sense cables installed on a circuit, the length of each sense cable, the nominated zones, associated sense cables, as well as the overall length installed.

In order to explore the fault information, several tools are available. The FG-SYS digital unit is equipped with eight configurable dry contacts: the choice of dry contact is associated with a cable and the type of fault (leak, discontinuity, or both). Two independent serial links of type RS232/RS485, with a JBUS/MODBUS communication protocol, are used for the connection to a supervisor.

This document is downloadable from our web sites: www.ttkuk.com; www.ttkasia.com; www.ttkcanada.com; www.ttk.sg; www.ttkusa.com

The information contained in this document can be the subject to modifications without notice. This information and diagrams were drawn up carefully, however TTK UK Ltd., TTK Asia Ltd. or TTK S.A.S. cannot guarantee that the provided information does not contain any error or omission and cannot accept any comparative responsibility with which the information is used. No part of this guide can be reproduced or transmitted without the express and written permission from the Companies TTK UK Ltd., TTK Asia Ltd. or TTK S.A.S.

FG-SYS and TOPSurveillance are trademarks of TTK S.A.S. © TTK 2023

- TTK Headquarters / 19, rue du Général Foy / 75008 Paris / France / T : +33.1.56.76.90.10 / F : +33.1.55.90.62.15 / www.ttk.fr / ventes@ttk.fr
- TTK UK Ltd. / 3 Luke Street / London EC2A 4PX / United Kingdom / T : +44 207 729 6002 / F : +44 207 729 6003 / www.ttkuk.com / sales@ttkuk.com
- TTK Pte Ltd. / #09-05, Shenton House, 3 Shenton Way / Singapore 068805 / T : +65.6220.2068 / M : +65.9271.6191 / F : +65-6220.2026 / www.ttk.sg / sales@ttk.sg
- TTK Asia Ltd. / 2107-2108 Kai Tak Commercial Building / 317 Des Voeux Road Central / Hongkong / T : +852.2858.7128 / F : +852.2858.8428 / www.ttkasia.com / info@ttkasia.com
- TTK Middle East FZCO / Building 6EA, Office 510 PO Box 54925 / Dubai Airport Free Zone / UAE / T : +971 4 70 17 553 / M : +971 50 259 66 29 / www.ttkuk.com / cgalniche@ttk.fr
- TTK Deutschland GmbH / Berner Strasse 34 / 60437 Frankfurt / Deutschland / T : +49(0)69-95005630 / F : +49(0)69-95005640 / www.ttk-gmbh.de / vertrieb@ttk-gmbh.de
- TTK North America Inc / 1730 St Laurent Boulevard Suite 800 / Ottawa, ON, K1G 5L1 / Canada / T : +1 613 566 5968 / www.ttkcanada.com / info@ttkcanada.com
- Thomas Sales & Marketing Inc. TTK Master Distributor For USA / 7200 W 66th St / Bedford Park, IL 60638 / The United States / T : +1 630-518-4724 / www.ttkusa.com / dmlork@ttkusa.com

INDEX

CERTIFICATIONS

I FG-SYS DIGITAL UNIT INSTALLATION

1. Fixing the Digital Unit
2. Electrical Characteristics
3. Electrical Connection of the FG-SYS
 - 3.1. Connection of the FG-SYS Digital Unit to the Earth
 - 3.2. Connection of the Power Supply Cable
 - 3.3. Connection of the Leader Cable FG-CLC
 - 3.4. Connection of the Relays
 - 3.5. Connection of the Serial Cable
 - 3.6. Closing of the FG-SYS Digital Unit metal enclosure

II SENSE CABLE AND ACCESSORIES INSTALLATION

1. Sense Cable Installation
 - 1.1. Hold down clips and cold adhesive with CF-EC100
 - 1.2. Installing Sense Cables FG-EC, FG-AC and FG-ECX
 - 1.3. Identification or Labeling with ES-EC Tags
2. Jumper Cable FG-NC Installation
3. Accessories Installation
 - 3.1. FG-DTCS Addressable Box
 - 3.2. FG-DCTL– “Cut-to-Length” Addressable Box
 - 3.3. FG-DTC, TTK Bus Diversion
 - 3.4. End Termination Plug

III STARTUP OF THE SYSTEM

1. Powering of the FG-SYS Digital Unit
2. Standby Mode
3. Communication Configuration

IV TEST PROCEDURES

1. Function Test
2. Test of Leaks
3. Test of Cable Break
4. Drawing FG-MAP

V MAINTENANCE – FAULTS FINDING

1. Checking the System
2. Maintenance of the System
 - 2.1. Replacement of a sense cable
 - 2.2. Precaution for use and storage
 - 2.3. Addition of sense cables on an existing circuit
 - 2.4. Addition of a new circuit of sense cables
3. Trouble Shooting Guide

APPENDIX

Connection of Digital Unit FG-SYS F

CERTIFICATIONS

Electromagnetic Compatibility E.M.C.

FG-SYS F is in conformity with the requirements of the generic harmonized European standards:



IN 50081-1 (92) for the emissions

IN 50082-1 (92) for immunity

Report/ratio of tests n° 8080612-CQPE/1 of the 14/09/1998

National laboratory of Tests 1, rue Gaston Boissier - 75724 Paris Cedex 15 – France - EU

Functional Test Certificate

Functional tests of FG-SYS, Liquid Leak Detection and location System, according to Test Report n° 041101971, dated on the 9th of November 2004.

FG-SYS has been tested by AdvEOTec Laboratory: AdvEOTec S.A.S.

6-8, rue Closerie, Lisses, CE5270 - Clos aux Pois F-91052 Evry Cedex – France - EU

Tel.: +33160864361 – Fax.: +33160864387- www.adveotec.com – Email: contact@adveotec.com

UL Certifications



Under the **File S9100**, the Control Number assigned by UL: **MW34**

Product Identity: "PROCESS MANAGEMENT FG-SYS EQUIPMENT"

I. FG-SYS DIGITAL UNIT INSTALLATION

1. FIXING THE DIGITAL UNIT FG-SYS

FG-SYS F Digital Unit is used in wall mounted version, with a metal enclosure. It is necessary to open the front face of the unit, to get access to the electronic chart.

Use the **accurate template** included in the FG-SYS F box, in order to fix the digital Unit at the wall.

The dimensions are the following:

Wide: 200 mm
High: 250 mm
Deep: 100 mm



FG-SYS F Wall Mounted, with Metal Enclosure



2. ELECTRICAL CHARACTERISTICS

- Power Supply:	100-240 VAC - 0.35-0.2A - 50/60 Hz
- Max. Consumption :	15W
- Power Thermal Fuse	2x0.5 A on the secondary
- Rating:	Class 2 not Inherent Limited

It is recommended electrically to protect the digital unit with a circuit breaker from 0.5 A.

Nine Dry Relays Characteristics:

Type :	1 RT Mechanical Signal Relay
Max. switching voltage. :	125 VAC / 60 VDC
Max. switching Intensity :	1 A
Max. switching capacity :	62,5 VA / 30 W
Working load min.:	5 VDC - 1 mA
Nominal load :	0,5 A à 125 VAC 1 A à 24 VDC

Sensing Cables:

- Rating :	12 VDC
- Nominal Voltage on the sense cable circuit (all voltages referred to Ground):	
- 1A, 2A, 3A, 1B, 2B, 3B:	5 VDC
- 1D, 2D, 3D:	12.3 VDC
- 1C, 2C, 3C:	0 VDC (electrically connected to Ground)

3. ELECTRICAL CONNECTION OF THE FG-SYS DIGITAL UNIT

Connections are done on the electronic board of the digital unit. The connector blocks are directly accessible and removable (male parts) on the FG-SYS F), it is necessary to turn the key button of the front face to open it.

See Appendix n°1: “FG-SYS F Digital Unit Connection” page 46, and also available separately inside the unit.

3.1 Connection of the FG-SYS Digital Unit to the Earth

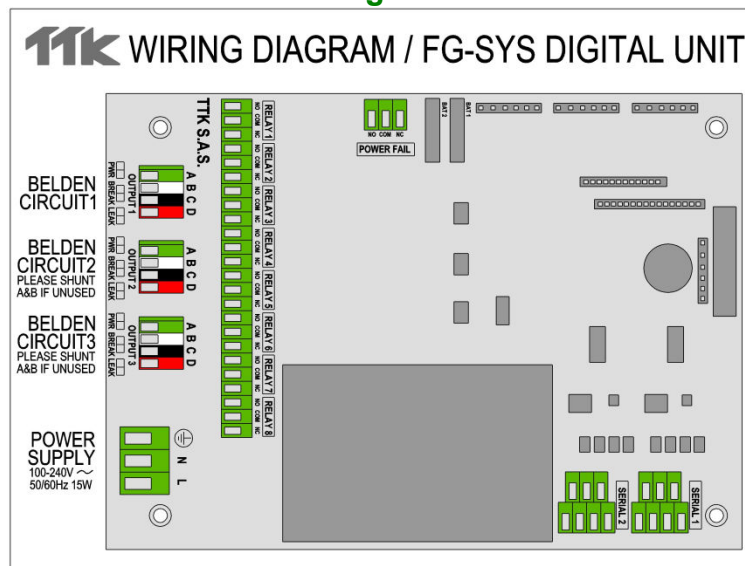

CAUTION:

Respect the rules for Electromagnetic Compliance standards - (E.M.I.):

It is absolutely necessary to connect the back of the front face to the site (building) earth.

The greenhouse cables and the screw n°3, with the identification "Earth", are available for this purpose.

3.2 Connection of the Power Cable

A power cable H07VV-F 3 x 1.5 mm², not provided by TTK, makes the electric connection of the digital unit. Connect the cable on the male and female connector blocks 3 points, for this use; remove the female to connect the power cable, and then place it back to the male.

The three terminals: **L, N and Earth** are indicated on the board.
Use the stuffing box n°3 for the cable.

(See Appendix n°1: FG-SYS F Digital Unit Connection)
Caution: Do not switch the FG-SYS Digital Unit On

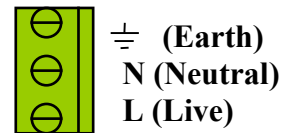

3.3 Connection of the FG-CLC Leader Cable

(See Appendix n°1: FG-SYS F Digital Unit Connection page 57, and also available separately inside the unit)

Each circuit of sense cables is connected to the FG-SYS Digital Unit with a TTK Leader Cable (Belden 8723), ref. FG-CLC

Caution: An inversion between the two couples red + black, and green + white, damages the electronic of the first connected sense cable.

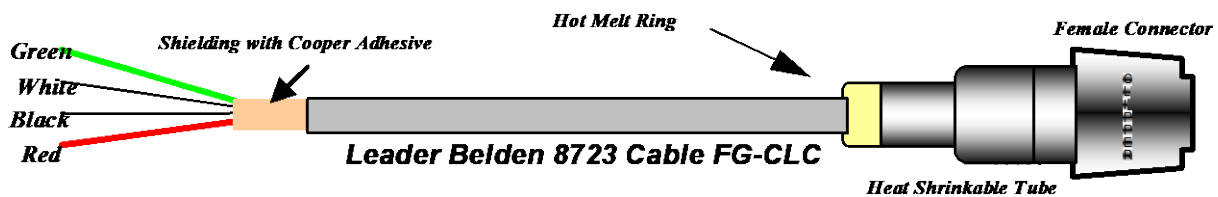

Three circuits are available; first of all to use circuit n°1, then if necessary, following circuits.

Each circuit has a maximum capacity of 40 sense cables.

When the circuit n°2 is used: Remove the existing shunt between 2A and 2B.

When the circuit n°3 is used: Remove the existing shunt between 3A and 3B.

Caution:

To avoid the electromagnetic disturbances and emissions (ECM), it is necessary to connect the shielding of the leader cable to the earth. Fix, using a metal cable clamp, the shielding of the leader cable (available to the back)

(See Appendix n°1: FG-SYS F Digital Unit Connection, page 46.)

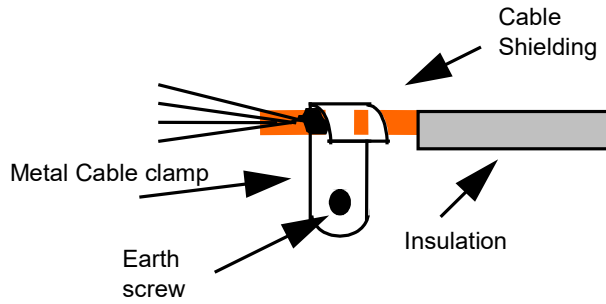

3.4 Connection of the Relays

Nine dry relays are available on the FG-SYS Digital Unit with 3 points connector blocks. The electric characteristics of these relays are the following:

Type:	1 RT
Max. Switching Voltage. :	125 VAC / 60 VDC
Max. Switching Intensity :	1 A
Max. Switching Capacity:	62,5 VA / 30 W
Working load min.:	5 VDC - 1 mA
Nominal load :	0,5 A à 125 VAC
	1 A à 24 VDC

You can configure each of the relay with the “Configuration” Menu (ref chapter III 3.2) .

Relays Configurations are the following:

- Normally Open (NO) or Normally Close (NC), depending on the wiring
- Default associated: Leak, Cable Break, Leak or Cable Break
- Associated cable : cable number

Power supply check contact:

An additional contact (not configurable) is available for checking the presence of power.

PLEASE NOTE THAT THESE RELAYS ARE AVAILABLE FROM THE PCB OF THE CENTRAL UNIT. They should not be confused with the optional Reed-relays Extension Boards described on page 35.

3.5 Connection of RS232 - RS422/485 serial links

The serial links are used for RS232/RS422/RS485 JBUS/MODBUS communication; they are available via the two connectors located above the power supply. (Refer to appendix 1.)

To configure the serial connections, follow the instructions in section III 3.2.

3.6 Closing the FG-SYS F Digital Unit

All connections being finished, close the FG-SYS F Digital Unit. Fix the part of the unit containing the circuit board on the part fixed at the wall. Be careful to the various cables connected and the flat ribbons during closing the front door. Turn the button to fix the door closed.

II SENSE CABLE AND ACCESSORIES INSTALLATION

FG-SYS System is modular. All the sense cables and accessories are pre-terminated with both male and female connectors. This makes the installation quick, easy, and safe.

We recommend drawing a precise map of all zones to be fitted with sense cables, ensuring that all installation zones are clean and dry before installation.

1. SENSE CABLE INSTALLATION

1.1 Installation: Hold Down Clips with Adhesive

The sense cables are fixed on the ground by fixing clips, type CF-EC100.

The first stage of the installation consists in sticking these clips on the ground using the provided adhesive (3M cold Glue).

Recommendations:

1. Ensure the cable sticks correctly to the earth, alternate the direction of the clips on the earth.
2. The clips must follow the drawing of the sense cables and be spaced approximately 1 metre apart.
3. Wherever there is a curve of the trajectory, stick 1 clip the entry point and a second at the exit point of curve.
4. Please wait for the clips to be completely dry (three to four hours), before installing the sense cables.
5. When fixing the sense cables into the clips, keep a length of approximately 10 cm between the connector and the clip.



Hold Down Clips with Adhesive (ref.: CF-EC100)

1.2 Installing sense cables: FG-EC, FG-AC and FG-ECX

Unroll the entire length of the sense cable and place in the clips fixed on the floor before installation.

Caution: Start with the right way of the sense cables installation.

The FG-CLC leader cable, connected to the FG-SYS Digital Unit with a female connector, at its extremity. **The beginning of the sense cable thus corresponds at its extremity with a male connector.**

1. Connect the first sense cable to the leader cable, coming from the FG-SYS Digital Unit
2. It is recommended that you avoid placing the cables in direct contact with the jacks (on the raised floor), the cable trays, any other obstacles...
3. Take care to circumvent the air-conditioning system (at a distance of approximately 50 to 75 cm), to avoid false leak alarms related to harmless water projections.
4. All partitions must be fitted with pre-determined neutral Belden 8723 cables: type FG-NC (1 or 3 metres).
5. Once the sense cables are fixed with clips, their length must be maintained along the flooring or ceiling in a closed retention tray, etc...
6. ES-EC tags must be placed along the length (packet of 40 tags) and spaced approximately every 4 metres.
7. Place a new length of sense cable (a pre-terminated neutral Belden 8723 cable and finish the circuit with a modular end termination plug.

1.3 Labeling with ES-EC tags

Labels ES-EC indicate the presence of sense cables installed. Part of the label is reserved to the user to note the distance rose, during water leak simulations.

1. Fix the labels every four meters on the circuit of sense cables.
2. Ensure itself of the good visibility of the labels.

Pack of 40 Tags, ref. : ES-EC



2. FG-NC JUMPER CABLE INSTALLATION

It can be necessary to use jumper cable for:

- Pass from a zone of detection to another
- Connect the Digital Unit to the first length of sense cable
- Pass through rooms...

Note: for the passages of rooms, stop the passage of the sense cable with a product adapted to the regulation and the architecture of your customer (partition firebreak, for example).

For a correct operation of the system, you have to use the following jumper cable:

BELDEN 8723 (LSZH, if required)

This jumper cable must be equipped with a male and female connector, in order to be compatible with the TTK sense cables. The FG-NC Kit includes for this purpose the following material:

- A male connector with its 4 contacts
- A female connector with its 4contacts
- 2 heat-shrinkable sleeves
- 2 rings of hot melt
- Notice for the realization of the jumper cable

Tools necessary:

- Material to be stripped
- Air Gun, with 800W power
- Flat-nose pliers

Jumper Cable Connexion

The random jumper cable is installed. The beginning of the cable is the end coming from the digital unit. Always start by making the connection at the beginning of the cable. The beginning of each cable must be provided with a male connector and the end of the jumper cable with a female connector.

At the beginning of the Belden jumper cable:



- Strip the external sheath on 20mm.
- Strip the 4 wires on 5mm.
- Do not cut the wire of shielding.



Crimp a male contact on each of the four wires. The wire of shielding is to be crimped in the same contact as the black wire.

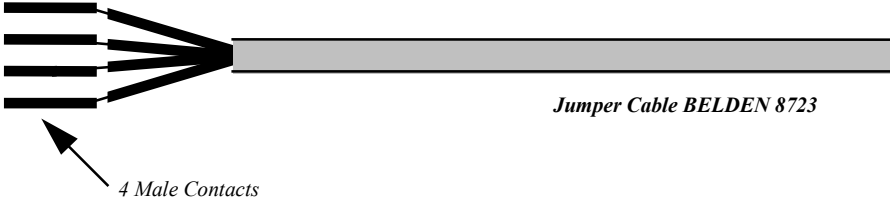

- Put a 45 mm Heat Shrinkable Tube on the Jumper Cable.

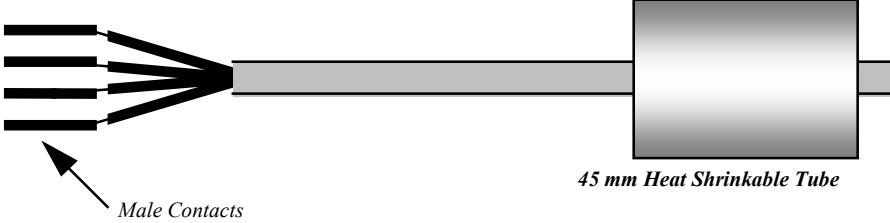

Prepare the Male Connector (the longest).
 Encase the 4 contacts in the connector,
 Draw the red plate while pressing on the sides (It is normal that it entirely did not leave).

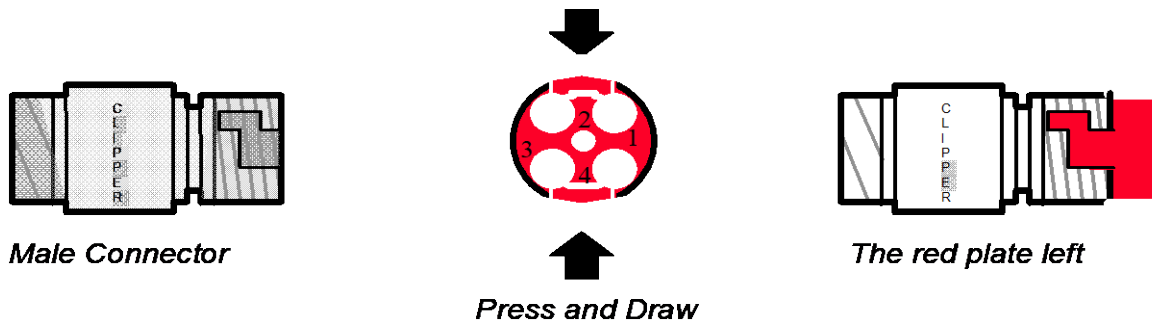

Insert the four contacts then, by respecting the following code:

- | | |
|-------------------------------|-------------------------------|
| Red Wire | : point n°1 of Male Connector |
| Black Wire + Shielding | : point n°2 of Male Connector |
| White Wire | : point n°3 of Male Connector |
| Green Wire | : point n°4 of Male Connector |

And then, give the red plate to its place while pressing on the sides.

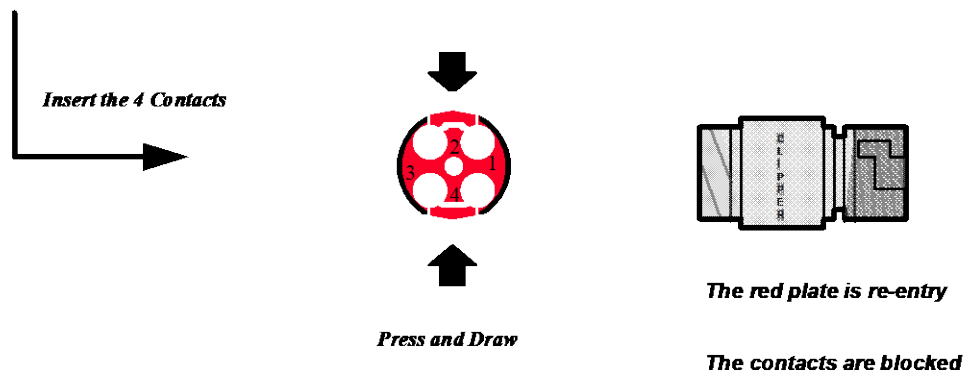
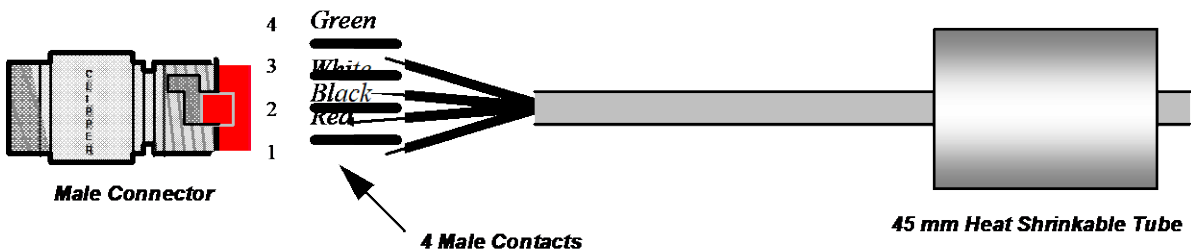

The wires and contacts are now blocked. This process makes it possible to remove the contacts very easily if necessary.

Caution: If the contacts are not entirely inserted in the connector, the red plate does not return.

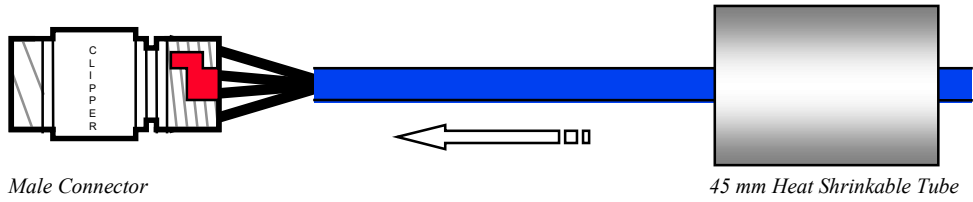

Cover connections and the screw pitch with the 45 mm Heat Shrinkable tube, slipped beforehand on the jumper cable.
Place a ring of adhesive (Hot melt) at the rear of the tube, side cable.

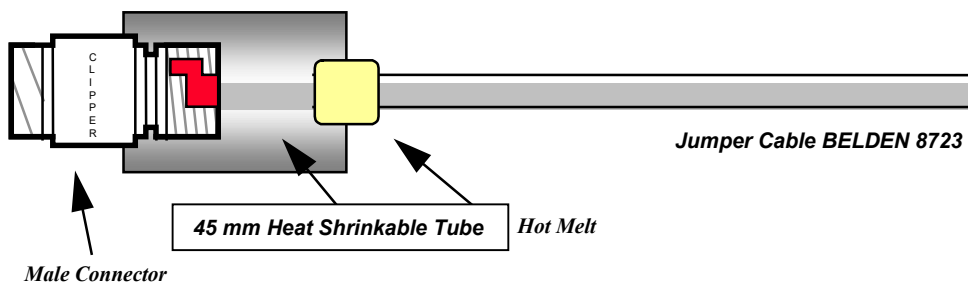

- Heat the whole with a warm air heater gun to shrink the tube down to the side of the male connector, all while it maintaining so that it remains well in place. Heat the whole of the heat-retractable sleeve then.
- Heat sufficiently to melt the ring of adhesive until visibility of the adhesive outside the tube (side cables).

Caution: Do not heat too much, otherwise the jumper cable risks to overheat and melt

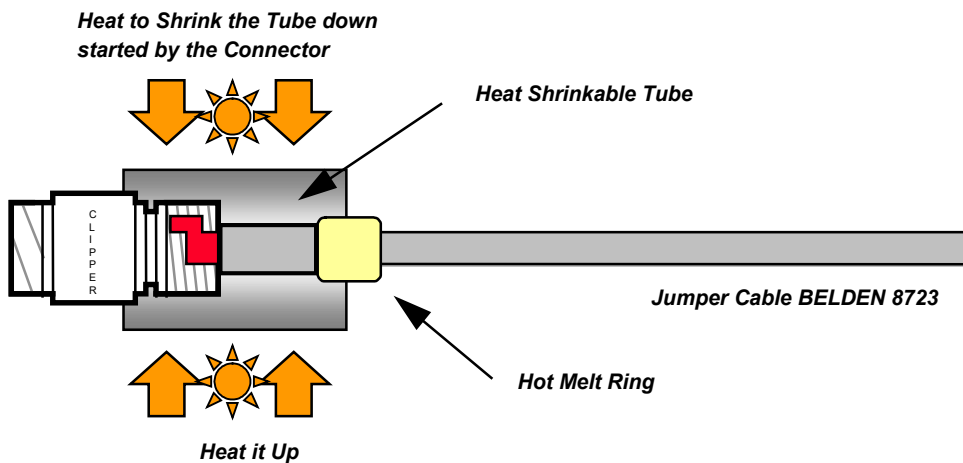

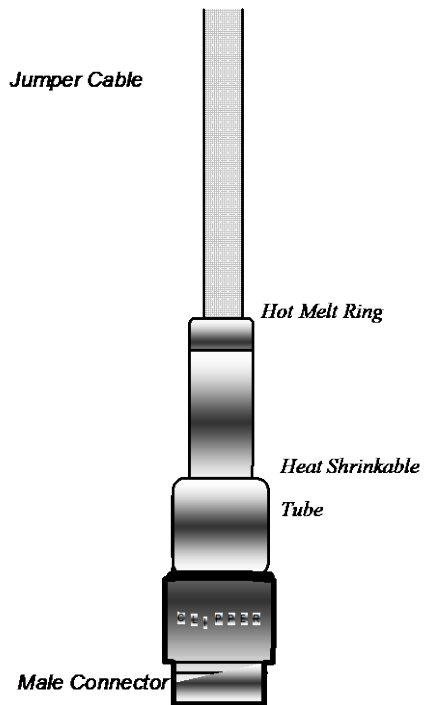

Let cool the Tube in driving position, connector downward.

Proceed in the same way for the other end with a Female Connector and Female Contacts.

DO NOT CONNECT THE WIRE OF SHIELDING:

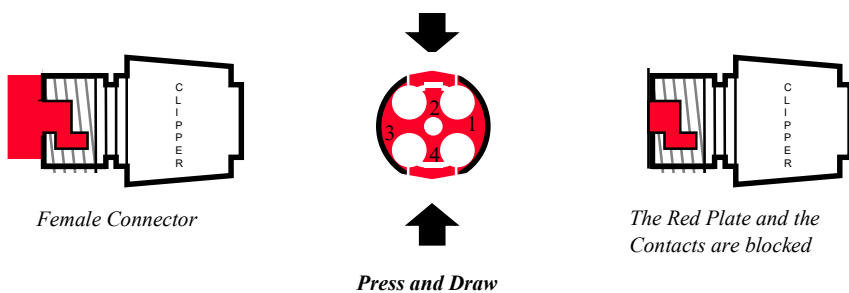
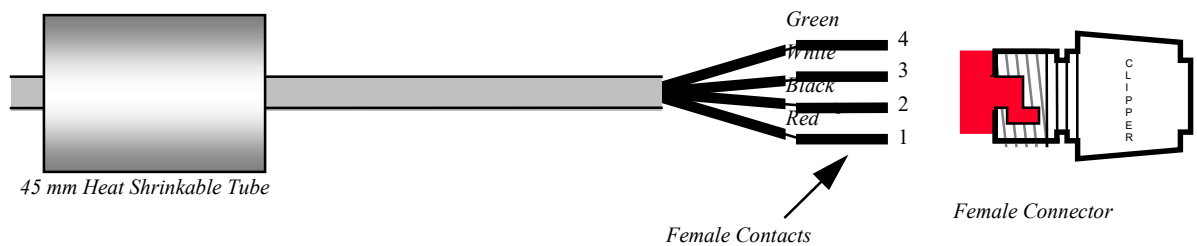

The diagram of the finished Jumper Cable is the following:

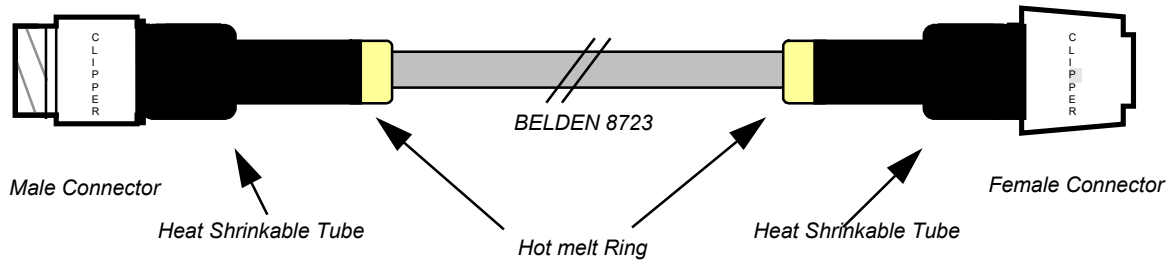

3. ACCESSORIES INSTALLATION

3.1. FG-DTCS Addressable Box:

The FG-DTCS diversion box allows connection of the FG-ECS sense cable on the main bus wire; this box is provided with three holes with grommets: ' INPUT', ' OUTPUT' and ' FG-ECS '.

FG-DTCS Diversion Box Diagram:

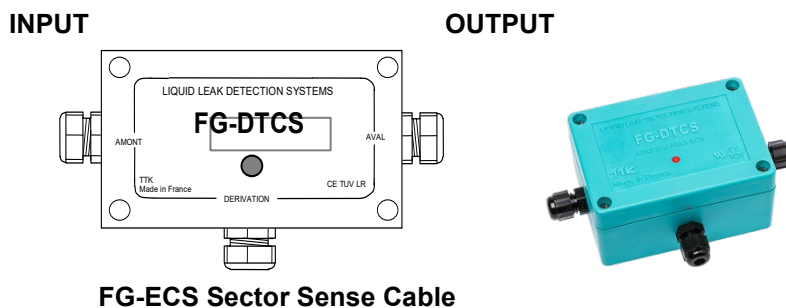

The schema of connection is located on the plastic bag of the sector diversion box. Refer to the diagram to connect the cables below.

Caution :

In the last Sector Diversion Box, We must end with a shunt in OUTPUT in the circuit board, between A and B.

Installation of the FG-DTCS Diversion box must be done when the FG-SYS Digital Unit is switched off.

INPUT corresponds to the Belden cable coming from the FG-SYS Digital Unit
OUTPUT corresponds to the Belden cable leaving towards the following Diversion Box
FG-ECS corresponds to the FG-ECS sense cable.

The LED on the front face of the box indicates the box's status in real time:

- Blinking green: normal, no alarm.
- Blinking red: leak detected on the box.
- No LED light: cable break detected on the box or loss of communication.

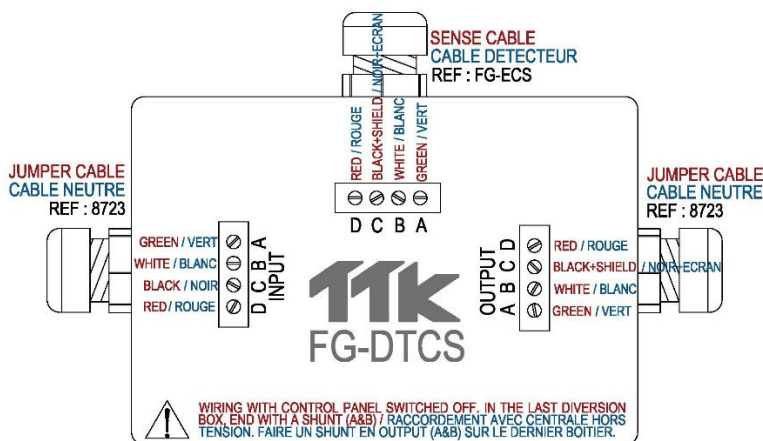

3.2 FG-DCTL – “Cut-to-Length” Addressable Box:

The FG-DCTL “Cut-to-Length” addressable box allows the connection of custom lengths (from 1 to 45 meters) of FG-ECS, FG-ACS, FG-ECX and FG-ACX sense cable to the main bus wire; this box is provided with three holes with cable glands: 'INPUT', 'OUTPUT' and 'SENSOR'.

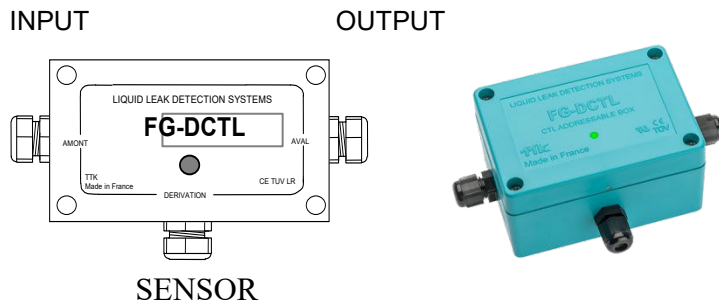

The connection diagram is located on the addressable box packaging. (See below for details)

Caution:

In the last FG-DCTL addressable box, the circuit must be completed with a shunt in the OUTPUT of the circuit board (between A and B).

The INPUT is linked to the Belden cable coming from the FG-SYS Digital Unit, or from the previous FG-DCTL addressable box

The OUTPUT is linked to the Belden cable leaving towards the next FG-DCTL addressable box

The SENSOR output is linked to the FG-ECS, FG-ACS, FG-ECX or FG-ACX sense cable.

Up to 30 FG-DCTL boxes can be installed on one circuit, with a maximum of 70 FG-DCTL boxes on one panel.

The LED on the front face of the box indicates the box's status in real time:

- Blinking green: normal, no alarm.
- Blinking red: leak detected on the box.
- No LED light: cable break detected on the box or loss of communication.

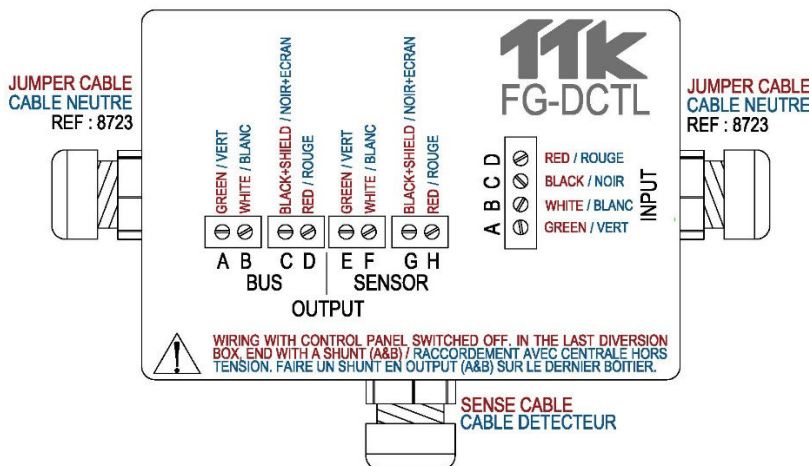

3.3 FG-DTC, TTK Bus Diversion

The TTK Bus Diversion box makes it possible to break up a detection circuit into two parts. The box is provided with three cable glands: 'INPUT', 'OUTPUT2' and "OUTPUT1".

FG-DTC Diversion Box Diagram:

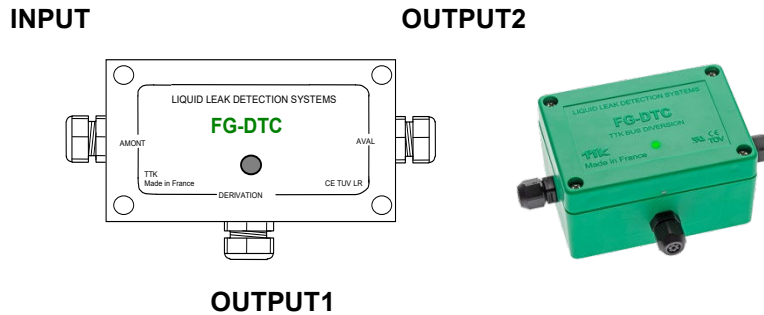

The connection diagram is located on the box packaging.

See below for instructions on how to connect the FG-EC or FG-AC cables to the main bus wire, or to connect the sense cables to each other.

The INPUT is linked to the **Belden cable coming from the FG-SYS Digital Unit**, or from the last FGDTCS diversion box

OUTPUT1 is linked to the FG-EC or FG-AC sense cables.

OUTPUT2 corresponds to the Belden cable at the end of the circuit.

The LED on the front face of the box indicates the box's status in real time:

- Blinking short blue followed by a long green: normal, no alarm.
- Blinking short blue only: cable break detected on the box.
- No LED light: loss of communication.

CAUTION: When an output is not being used (for example OUTPUT 2 in the last diversion box), a shunt is needed between A and B.

CAUTION: Installation of the FG-DTC Diversion box must be done when the FG-SYS Digital Unit is switched off.

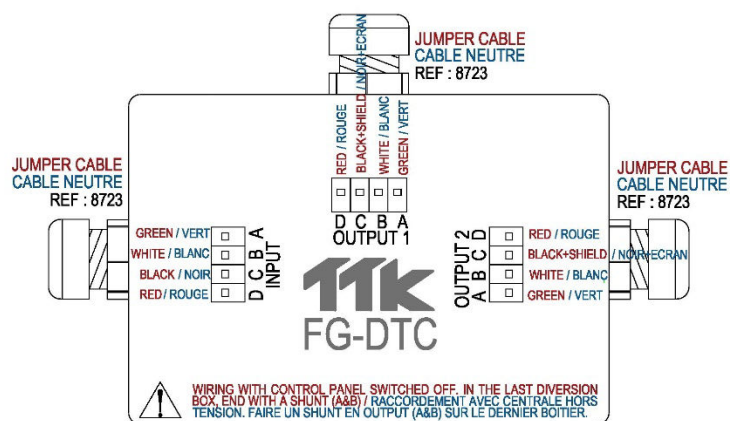

3.4 End Termination Plug

3.4.1. FG-TMC End Termination Plug

(Use Only with FG-EC or FG-AC Sense Cables)

Each circuit of sense cable must be end with an End Termination Plug. FG-TMC is used for the circuit continuity.

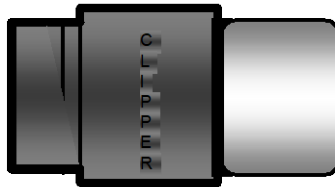

3.4.2. FG-TMX End Termination Plug

(Use Only with FG-ECX or FG-ACX Sense Cable)

Analogue End Termination Plug FG-TMX

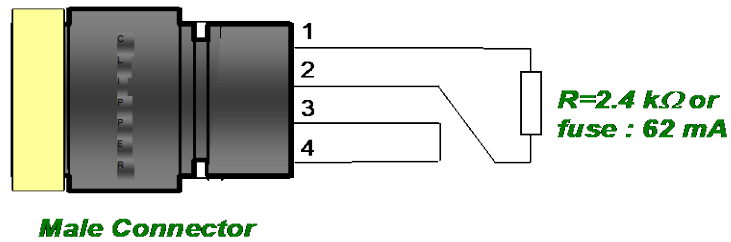

III STARTUP OF THE DIGITAL UNIT

1. POWERING OF THE FG-SYS DIGITAL UNIT

When all of the cables - leader cables, jumper cables, sense cables, power supply cables - and the accessories – diversion boxes, end termination plugs- are connected, switch the FG-SYS Digital Unit ON.

When the digital unit is turned on, it goes into TEST mode: an audible alarm sounds and a luminous witness glows red. The luminous witness turns to green while the digital unit is under TEST, shown on the display.

```
SYSTEM UNDER TEST
VERSION 0109/6-017
```

The digital unit tests one circuit after the other. Three circuits of sense cables are available on the digital unit. In the majority of cases, only one circuit is used. The display indicates the length of each sense cable, as well as the overall length of the circuit.

```
CIRCUITS UNDER TEST
CABLE # 1:           7m
001-COMPUTER ROOM 1
TOTAL CIRCUIT:      7m
```

```
CIRCUITS UNDER TEST
CABLE # 2:           15m
002-COMPUTER ROOM 1
TOTAL CIRCUIT:      22m
```

```
CIRCUITS UNDER TEST
CABLE # 3:           7m
003-TGBT
TOTAL CIRCUIT:      29m
```

Once the test is finished, the digital unit passes into MONITORING mode:

```
On 14/05/2016      15:05
« SITE NAME »
UNDER CONTROL
[ H ] isto [ T ] est [ M ] enu
```

FG-SYS SYSTEM MAP

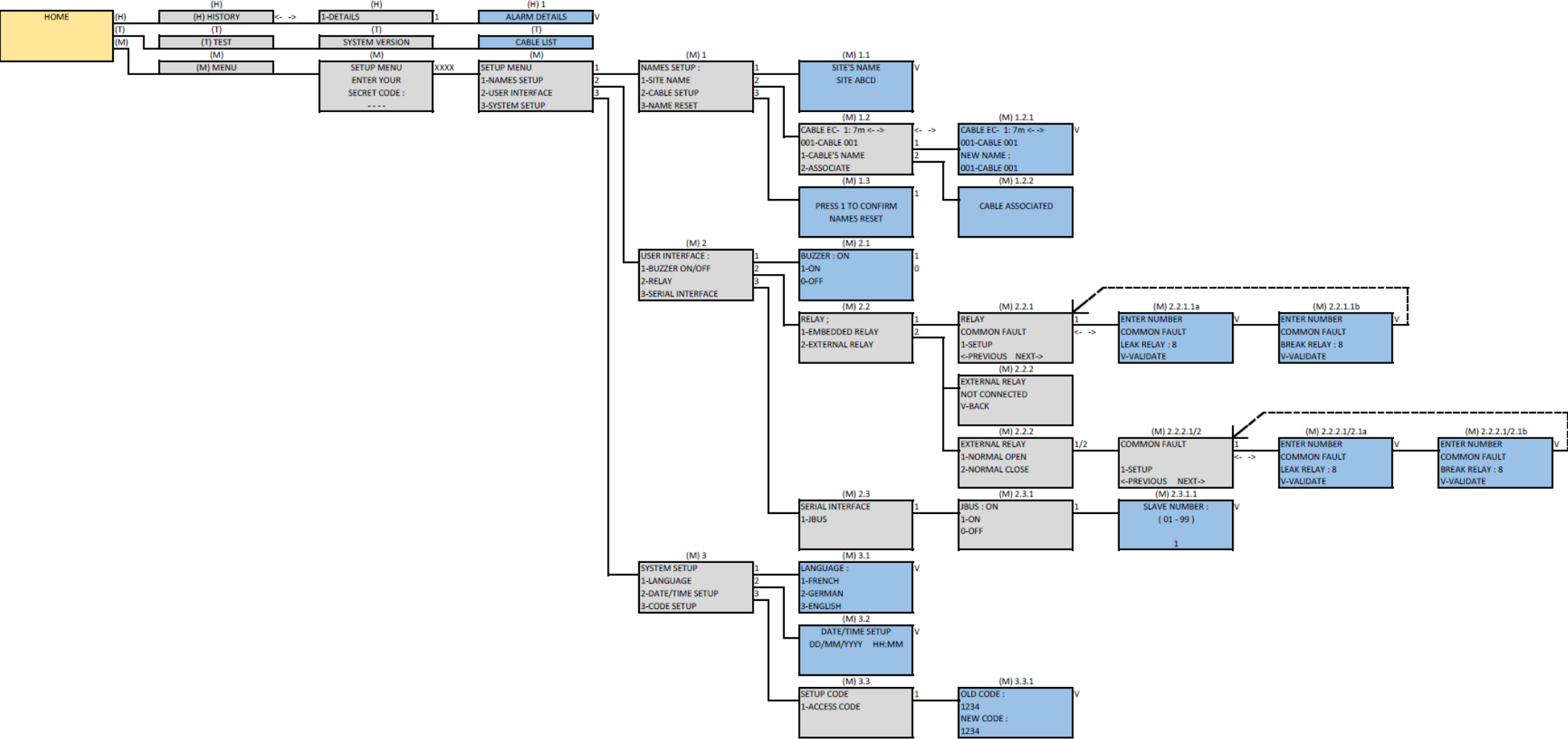

2. STANDBY MODE

The Configuration Menu - accessible via the letter [M] - is used to set the parameters of the digital unit. To access it, you must enter your secret code.

The factory access code is: 1234. You can change it in this menu.

```

SETUP MENU
1-NAME SETUP
2-USER INTERFACE
3-SYSTEM SETUP
    
```

You can access 3 sub-menus by typing the corresponding number:

(M) 1: SETUPS

(M) 2: OPERATION

(M) 3: SYSTEM PARAMETERS

(M) 1. SETUPS

(M) 1.1 SITE NAME

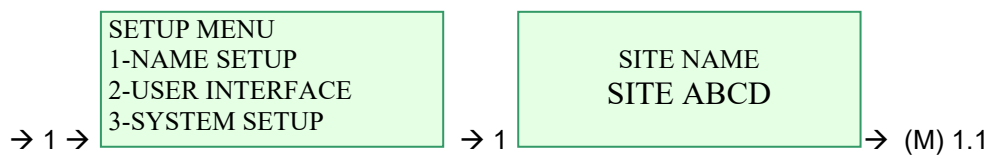

This sub-menu allows you to set the name of the site or of the digital unit itself in the event that several digital units are used in the same installation.

(M) 1.2 CABLE NAME

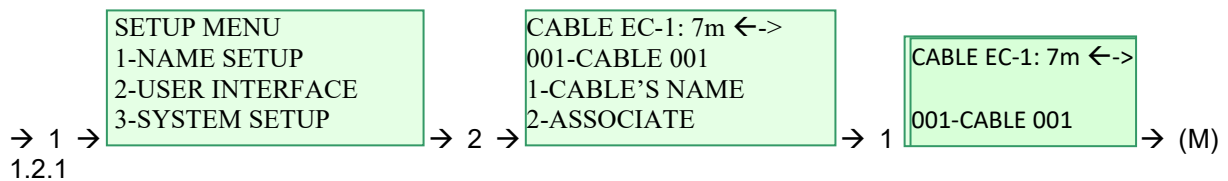

The user may utilize up to 16 characters to assign a name to each sense cable. (Menu 1.2.1)

You can also associate a sense cable with the previous cable (Menu 1.2.2).

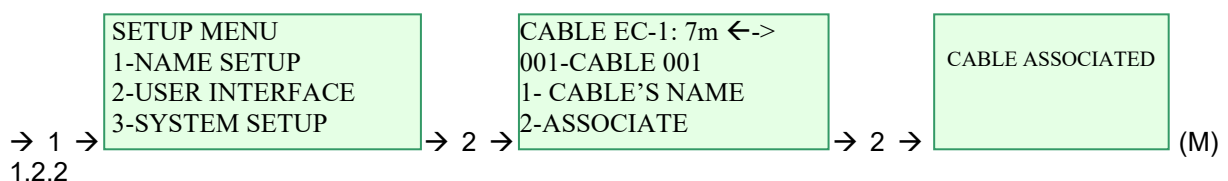

The association allows you to create a group of cables.

Within this group, the first cable is the Master and the subsequent cables are dependants.

The parameters for naming and assignment of relays that are applied to the Master cable will also be applied to the dependent cables.

However, each sense cable retains its capacity to detect leaks and to independently issue alarms.

The location of the alarms, in metres, will no longer be performed in terms of the cable, but is performed instead on the group.

Example: four 15 m cables are associated to form a group of 60 metres. In the event of a leak detected by the third cable of the group, the alarms will be located between 31 m and 45 m instead of between 1 m and 15 m.

(M) 1.3 SETUP RESET

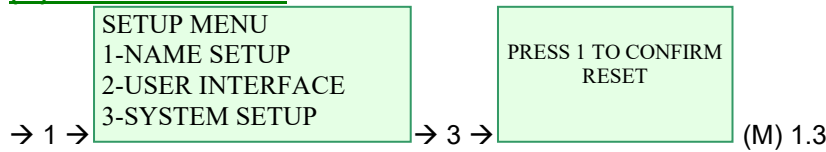

Reset is used to restore the factory-setting names. This action is not reversible.

(M) 2. OPERATION

(M) 2.1 BUZZER ON/OFF

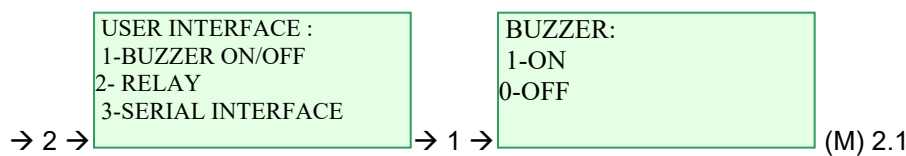

The audible alarm can be enabled or disabled.

When the audible alarm is enabled, the digital unit sounds continuously and must be silenced manually by pressing the "V (ESC)" button.

When the audible alarm is disabled, the digital unit only sounds during the self-test procedure at system startup, or when pressing the "TEST" button.

(M) 2.2 DRY CONTACTS

(M) 2.2.1 INTERNALRELAYS

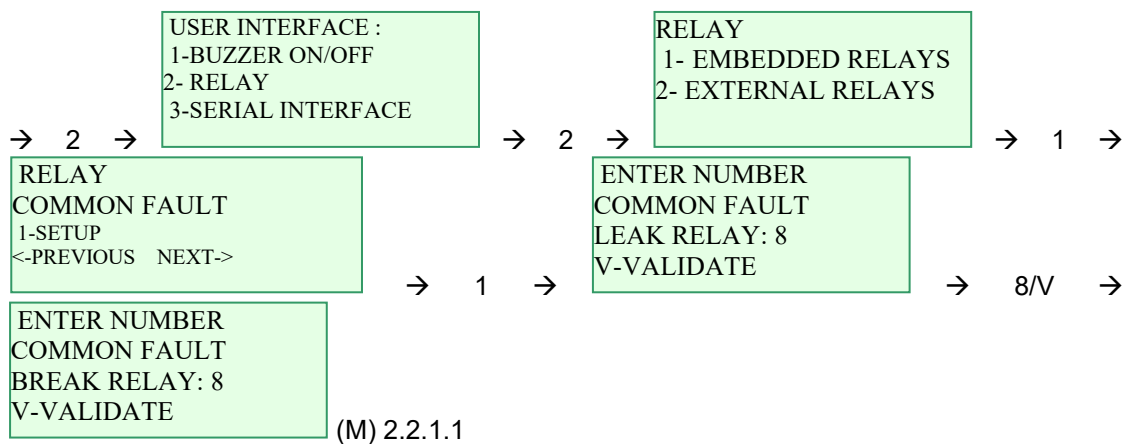

The digital unit is equipped with a dry contact to check for the presence of power (POWER FAIL). This contact is not configurable.

There are eight (8) dry contacts on the digital unit, configurable via 3-point terminal blocks. They can be used Normally Open (NO) or Normally Closed (NC), depending on their wiring. The type of fault with which they are associated - leak, discontinuity or both - can be defined, together with the set of sense cables on which they will be enabled.

Go to MENU (M) → OPERATION → DRY CONTACTS → INTERNAL RELAYS

The first contact to configure is the synthesis fault. Press 1 to CONFIGURATE.

Choose a relay number to activate for the synthesis of leaks, then confirm using the V button.
The screen then proposes the discontinuity synthesis, for which the relay number will necessarily be the same as for the leak synthesis. Re-confirm using the V button.

The digital unit screen returns to the previous menu.

Press the right arrow button to configure a relay linked to alarms on cable 001.

Choose a relay number for the leaks and confirm. Then choose a relay number for the discontinuities and confirm.

Press the right arrow to go to cable 002 and so on for all the sense cables installed on the system.

Relays Wiring Diagram:

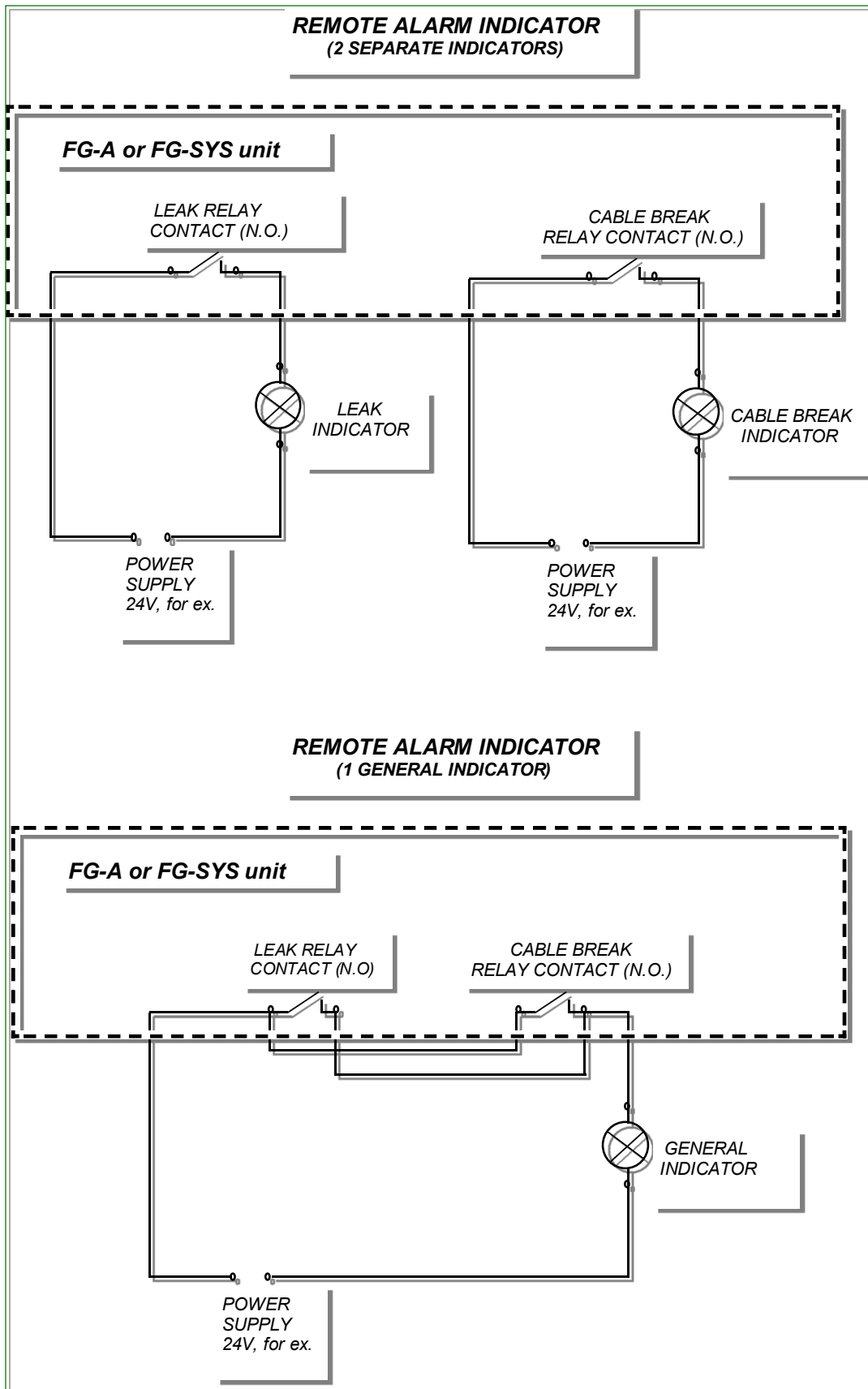

CONNECTIONS TO OPTIONAL POWER SUPPLY SUPERVISOR

(These applications were not evaluated by UL)

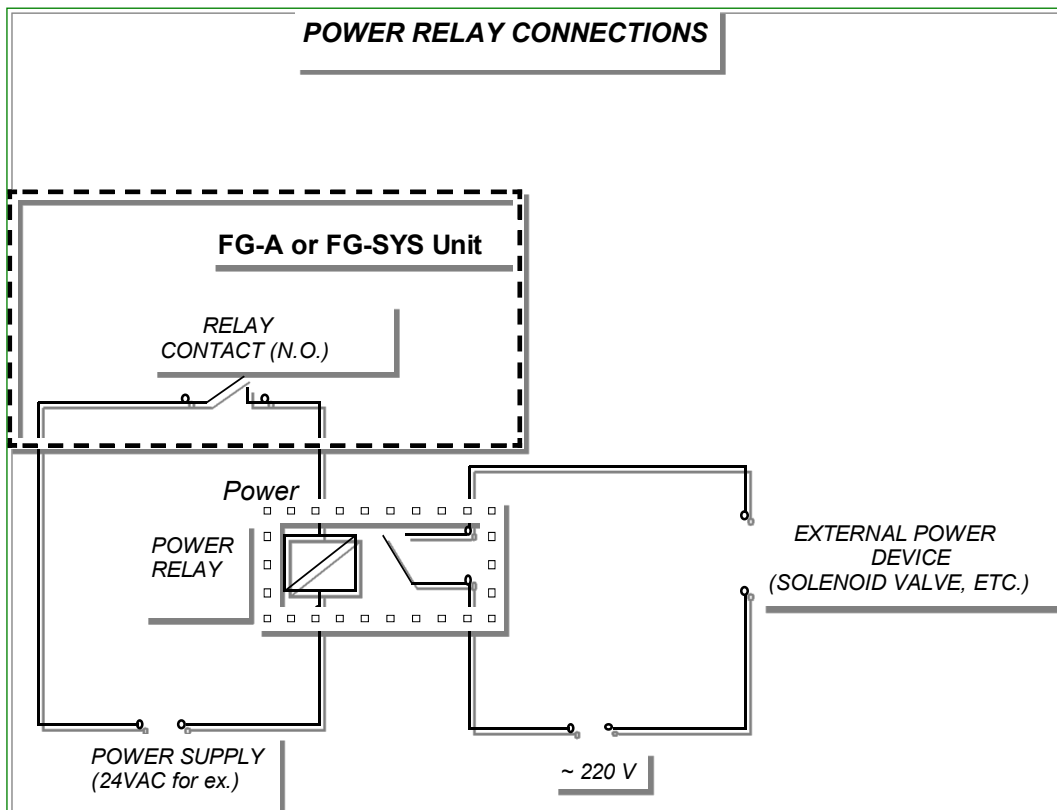
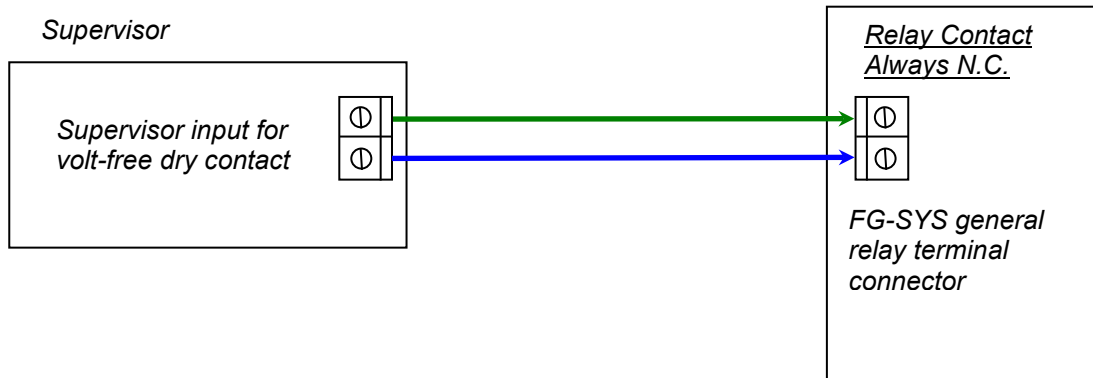

(M) 2.3 RS232, RS422, RS485 JBUS/MODBUS COMMUNICATION

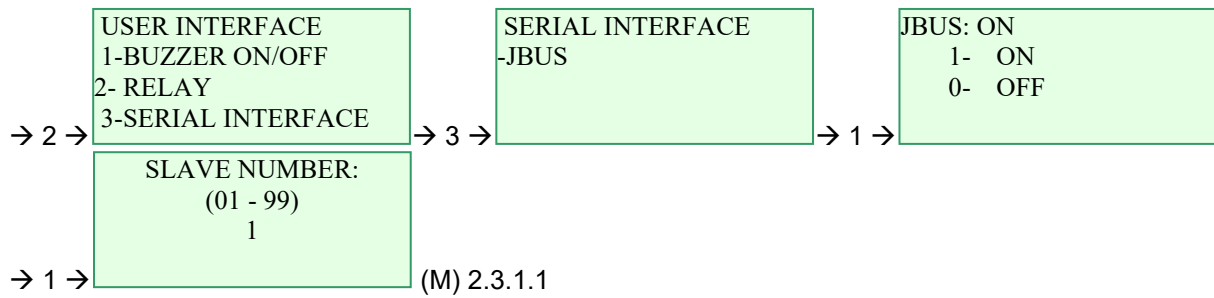

The FG-SYS digital unit is equipped with two independent serial interfaces. Each interface can be used, either:

- With RS232, three-wire connection:
 - Rx
 - Tx
 - GND

- **or** RS422, four-wire connection:
 - Rx-
 - Rx+
 - Tx-
 - Tx+

- **or** RS485, two-wire connection:
 - RT-
 - RT+

Serial interface No. 1 may be used to communicate with a supervisor (TOPSurveillance, GTC, MODSCAN32, etc.)

Serial interface No. 2 can be used to drive the system of external relays **or** to communicate with a supervisor.

To activate the JBUS/MODBUS function, go to MENU (M) → OPERATION → SERIAL COMMUNICATION → JBUS → ON, adjust the slave No. and then confirm with the V button.

(M) 3 SYSTEM PARAMETERS

This sub-menu allows you to choose the language used, to initialize the time and date, and to set a password for access to the configuration system.

All these parameters are kept in memory when the digital unit is turned off.

(M) 3.1 LANGUAGES

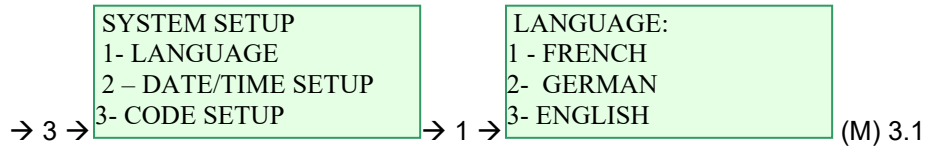

Language: Three languages are available: **English, French and German.**

(M) 3.2 SETTING THE TIME AND DATE

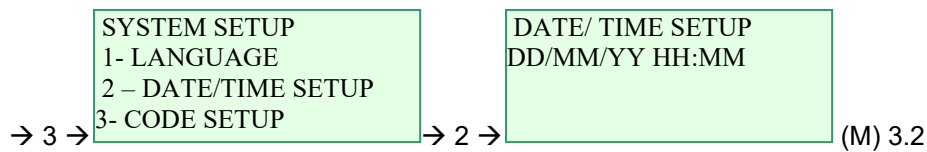

Setting the time and date

- Enter the time and date, then confirm with the V button.

(M) 3.3 SYSTEM ACCESS



■ **System access**

This sub-menu allows you to set a password that will be required in order to make any change to the configuration.

3. Communication Configuration:

Supervising the FG-SYS Digital Units using TOPSurveillance™ Software

3.1. General

The supervision of the FG-SYS Digital Unit is achieved using the JBUS/MODBUS protocol and the serial link RS232C or RS422/485.

These JBUS and MODBUS master-slave type protocols have been developed to allow monitoring of multiple security systems (slaves) by a master supervisor, via a single cable (or other physical media); these security systems are identified by a unique slave number.

The communication is always point-to-point, type question-answer, with only one device using the connexion line at a time.

The user of our FG-SYS Digital Unit could configure slave numbers from 1 to 99 and thus the simultaneous connexion of several central units to existing communication line is easy and very simple to do.

The TOPSurveillance™ is a supervisor software developed especially for the liquid leaks detection and location FG-SYS Digital Unit. This software is installed on a PC or another Microsoft Windows-compatible workstation. The physical connection between the PC and the FG-SYS detection digital unit(s) is achieved via a serial cable, connected to the serial port on the PC and on one of the two serial terminal blocks available on the circuit of the digital unit(s).

The use of the JBUS (MODBUS) protocol permits downloading all the useful information from the central units to the PC and the association of the digital data about the liquid leaks with a pin-pointing representation of the alarms on the map of the supervised area.

For one central unit and for short serial link (up to 100 m), it is recommended to use the RS232C interface implemented on both the PC and the FG-SYS central units.

To connect multiple digital units, and for distances exceeding 100 m, it is imperative to use the RS422 or RS485 interface, available from the SERIAL 1 or SERIAL 2 connectors of the FG-SYS digital units.

The serial ports on the PC are usually RS232. Therefore, it is also necessary to connect an RS422 (RS485)-RS232C adapter between the JBUS connecting cable and the serial port on the PC. The connecting cable must have a characteristic impedance close to 120 ohms and the maximum length of this cable between the PC and the most remote digital unit must be less than 1200 m.

(™) FG-SYS and TOPSurveillance are trademarks of TTK S.A.S..

3.2. Electrical connexions:

3.2.1 RS232 For One Single FG-SYS Digital Unit (max 100m):

PC serial port 1 DB9 FG-SYS Digital Unit RS232

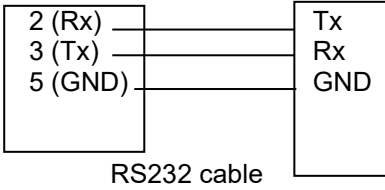

3.2.2 RS422 For Several FG-SYS Digital Units (max 1200m):

PC serial port 1 DB9 RS232/RS422 Converter DB25 RS422 interface FG-SYS Unit N°1 RS422/485 terminal FG-SYS Unit N°2 ... RS422/485 terminal

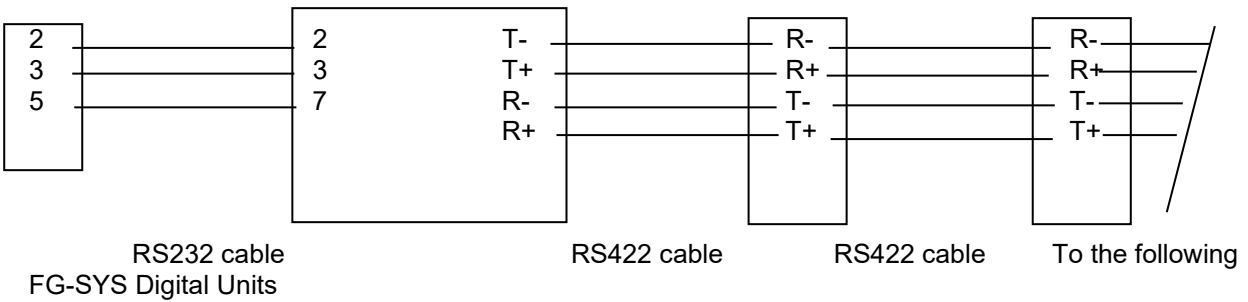

3.2.3 RS485 for multiple FG-SYS digital units (1200 m max):

The RS485 interface is obtained via the RS422 interface
Connect Rx- and Tx- together to obtain RT- (or Data-, or A), and connect Rx+ and Tx+ together to obtain RT+ (or Data+, or B)

PC serial port 1 DB9 RS232/RS485 adapter DB25 RS485 interface FG-SYS 1 RS422/485 terminal block FG-SYS 2 ... RS422/485 terminal block

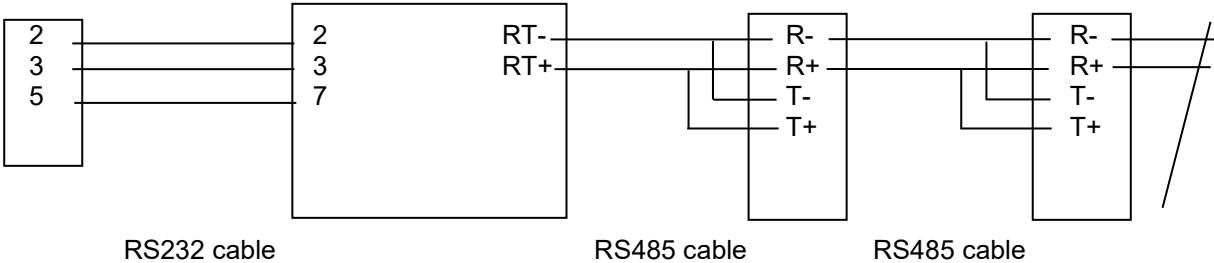

3.3. Physical Representation of a Sample Site with Several FG-SYS Digital Units Connected to the Same Supervisor, B.M.S.:

(Remark: These systems were not evaluated by UL)

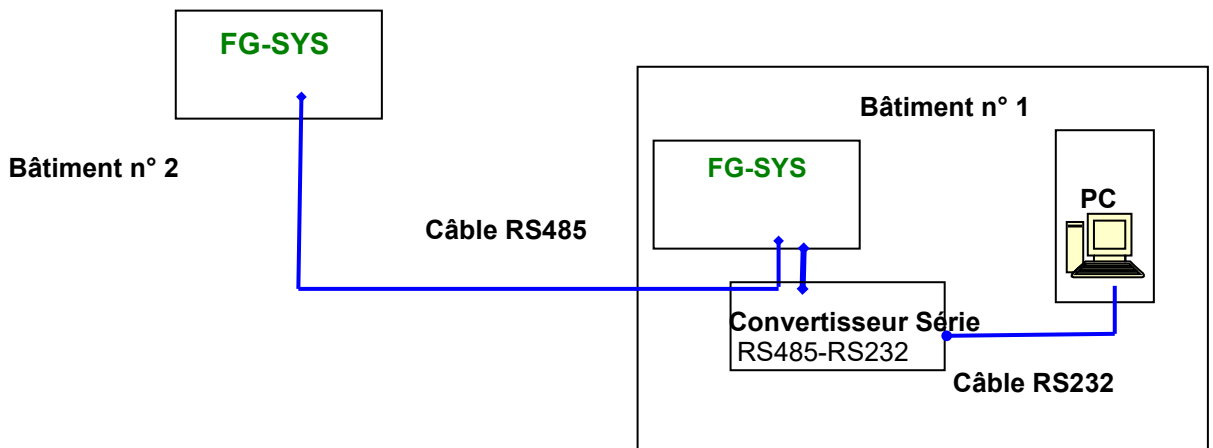

4. Minimum equipment required for the installation of TOPSurveillance™:

- 4.1. Pentium III (or equivalent) workstation with mouse, keyboard and available serial port RS232C
- 4.2. OS Windows '98, 2000, XP, NT, Vista, Windows 7 (32 or 64 bit) or Windows 8 (32 or 64 bits)
- 4.3. SVGA graphics card with 4 MB VRAM
- 4.4. Sound card and speakers
- 4.5. SVGA display with a 1024x768 resolution
- 4.6. Memory 252 MB RAM
- 4.7. 1 GB hard disk minimum
- 4.8. CD-ROM

For a single FG-SYS detection unit:

- 4.9. DB9 RS232 serial cable between the FG-SYS and PC

For several FG-SYS detection units or when the distance between the PC and the FG-SYS detection unit is greater than 100 meters:

- 4.10. RS232/RS422 or RS485 converter
- 4.11. DB9/DB25 RS232 serial cable between the converter and the PC
- 4.12. RS422 or RS485 cable (120 Ohms) between the converter and (or) plant (s) FG-SYS

5. JBUS Communication

The integration on the FG-SYS JBUS/MODBUS protocol Digital Units permits the supervision of the current status of all connected sense cables. The two types of alarms – leak and cable break – are coded using different flags and the location is represented in metres.

Following the creation of new features, a new Modbus Table has been created for the FG-SYS; however former Modbus Table has been retained in parallel for compatibility reasons.

The former Modbus Table can be found in the FG-SYS Digital Unit documentation.

Physical connection

The information provided by the Digital Unit can be exploited in different ways:

- Modbus TCP (Modbus over IP) port 502.

- Serial link RS232 or RS422/485.

The serial link is asynchronous.

The serial link and Modbus protocol settings are as follows:

<i>Serial port setup:</i>	9600 B, 8 data bits, 1 stop bit, no parity;					
<i>Communication protocol:</i>	JBUS or MODBUS, function 3 or 4;					
<i>Slave number:</i>	1 - 247 (configurable);					
<i>Maximum number of records read by request:</i>	100					
<i>Answer Format:</i>						
<i>num. slave</i>	<i>function</i>	<i>nb of Registers</i>	<i>Register 1</i>	<i>Register 2</i>	<i>... Register n</i>	<i>CRC 16</i>
/ 1, 2... 99 /	3 or 4 /	up to 100 /	XXXXh /	XX XXh / ... /	XXXXh / XXXXh /	

For the proper functioning of the RS485, it is necessary to connect Rx+ with Tx+ and Rx- with Tx-. In addition, it is essential to complete the line of communication via a two-wire resistance of 120 Ohms. The connection of the screen is provided on the supervisor side. The polarisation of communication lines from RS422/485 must be ensured by the supervisor. It is recommended to provide a break of at least 500 mms between JBUS polls.

Caution!

The simultaneous use of RS232 and RS422/485 interfaces causes the serial interface of the FG-SYS Digital Unit to power down.

Interpretation of information

There are three series of Registers for the sense cables state (addresses are expressed in decimals)

The first series (7000) is used for the types of alarm.

- Leak (bit 4)
- Cable break in bus (bit 0)
- Cable break in sense cable (bit 1)
- Cable break in end termination plug (bit 2)
- All cable breaks (resumed bus, plug and sense cable) (bit 7)

The second series (8000) is used for the alarm status.

- New (bit 0)
- Selected (bit 1)
- Cleared (bit 2)
- Ejected (bit 3)

The third series (9000) is used for location (in meters) of alarms (bits 0 to 15)

The Register's address to refer to a particular cable with the following layout:

- First digit for the series (7, 8, or 9)
- Second digit for the sense circuit (1, 2, or 3)
- Last two digits for the position of the cable in the circuit (from 01 to 40)

Example: The Type Register for the seventh cable of the second circuit (cable 2_07) will therefore be Register 7207, and the Location Register for the same cable will be 9207.

Finally, four additional Registers provide information on the status of the system.

1. 4096. Digital Unit leak (bit 4) and cable break (bit 7) global status.
2. 4097. Circuit 1 leak (bit 4) and cable break (bit 7) global status.
3. 4098. Circuit 2 leak (bit 4) and cable break (bit 7) global status.
4. 4099. Circuit 3 leak (bit 4) and cable break (bit 7) global status.

Based on client needs and requirements, the user can query the set of Registers, in part, and/or use the additional Registers. This allows for simplified programming and adaptation to the specific BMS/BMC.

Remarks:

The end terminating plug can only encode cable breaks. For a circuit of N cables, it must be read N+ 1 Register (N Registers for the sense cables + 1 Register for the end terminator plug).

An ejected cable can no longer be set with an alarm, so it is normal to not to have any more information in the Type Register (7000).

Only the Status Register (8000) shows that this cable is ejected.

Contrary to what existed in the former Modbus Table, the location expressed in metres is now identical to the value indicated on the unit's screen. It is therefore quite possible to have an alarm located at 472m in the case of associated cables.

Following the supervisor, the charset can be included or not in the interpretation of the response. In this case, the address of the cables will be N+1 (Example: cable 2_07 in address 7208 instead of 7207).

Tips:

An Excel table (ready to complete), and incorporating all this information, is available on TTK website.

The 'auto control' file contains a PDF file listing all sense cables connected to the system, as well as their names, lengths, states, and other useful information.

The embedded installation maps (optional) can be saved in the 'maps' folder.

Remove the SD card from the unit, read it using a PC and copy the necessary files (do not delete files) and then return the card to the unit.

The entire unit's information, loaded to its maximum capacity, is searchable using only 10 queries:

1. Types of alarm Circuit 1: Starting address 7101, length 40 Registers
2. Types of alarm circuit 2: Starting address 7201, length 40 Registers
3. Types of alarm circuit 3: Starting address 7301, length 40 Registers
4. States of alarm circuit 1: Starting address 8101, length 40 Registers
5. States of alarm circuit 2: Starting address 8201, length 40 Registers
6. States of alarm circuit 3: Starting address 8301, length 40 Registers
7. Location in metres to alarm circuit 1: Starting address 9101, length 40 Registers
8. Location in metres to alarm circuit 2: Starting address 9201, length 40 Registers
9. Location in metres to alarm circuit 3: Starting address 9301, length 40 Registers
10. Summary faults in unit per circuit: Starting address 4096, length 4 Registers

The Modbus function must be enabled in the unit's 'Setup' menu.

It is necessary to define the number of Modbus slaves when using the serial interface.

6. TOPSurveillance™ Software:

The supervising software TOPSurveillance™ is developed as one general driver assuming all the JBUS communication with the supervised central units, and one or several additional windows used for pin-pointing the alarms on the maps of the protected areas.

The driver requests continuously JBUS answers from the supervised central units and treats this data for the additional use by the dedicated windows. The status of each cable is downloaded to the PC and the general driver is also providing simple indication of the faults presence in each supervised zone. The proper use of the serial communication is also indicated by the corresponding simulated lamps. The loss of the communication with a central unit will change the corresponding lamp Digital Unit N in red and problems with the communication will turn red the indicator Serial error.

The visualisation of the current status of a particular zone is initiated by pressing the corresponding button Load/Update Map.

As soon as a leak or a cable break appears, the sound alarm advises the user.

The type of alarm and the zone where the fault appeared are displayed by a red lamp on the TOPSurveillance™ driver.



LIQUID LEAK DETECTION SYSTEMS
TOPSurveillance

Licensed User :
CLIENT'S NAME

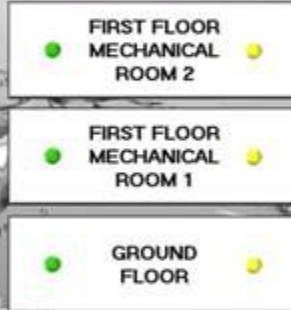

TTK ME ZFCO
Office 6EA 510
Dubai Airport Free Zone
DUBAI UAE
Phone : 0502598629
Fax: 043682735

<http://www.ttk.fr>
Update: 08.09.2015

PANEL 1
HEALTHY
GLOBAL
COMMUNICATION
PROTOCOL

Legend:
● Leak Detection = Healthy
● Cable Break = Healthy
● Blinking Red = Faulty

Cablebreak in first area (Data Centre)

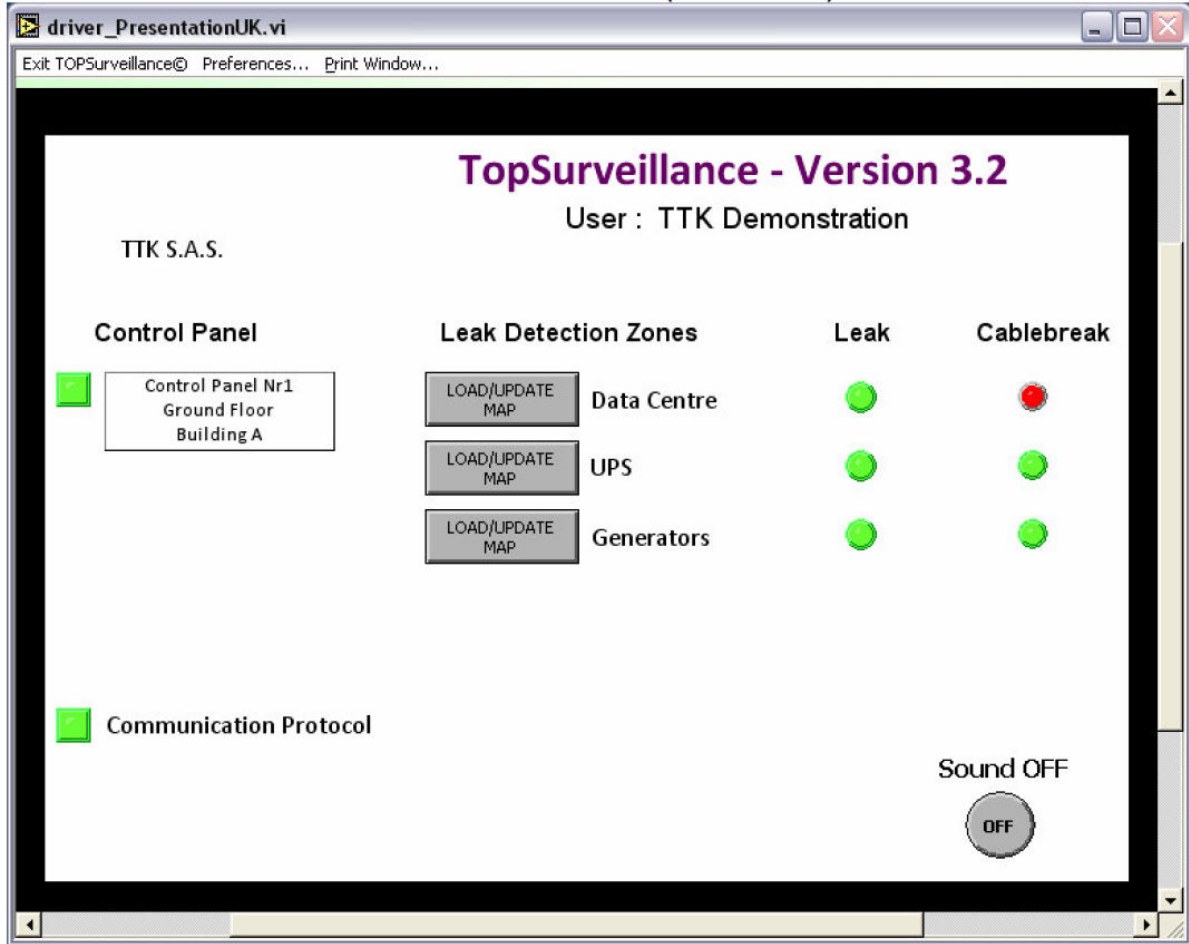

The sound alarm could be annulated by the press button Alarm Sound - OFF appearing on the driver window.

If an alarm disappears, the software will emit a very short sound and the corresponding red light alarm will pass to a normal, « green » status.

The map of each zone can be open using the corresponding press buttons Load/Update Map on the driver window. These maps show the actual status of a zone, with all the existing faults on the different zones.

Cablebreak in Data Hall A

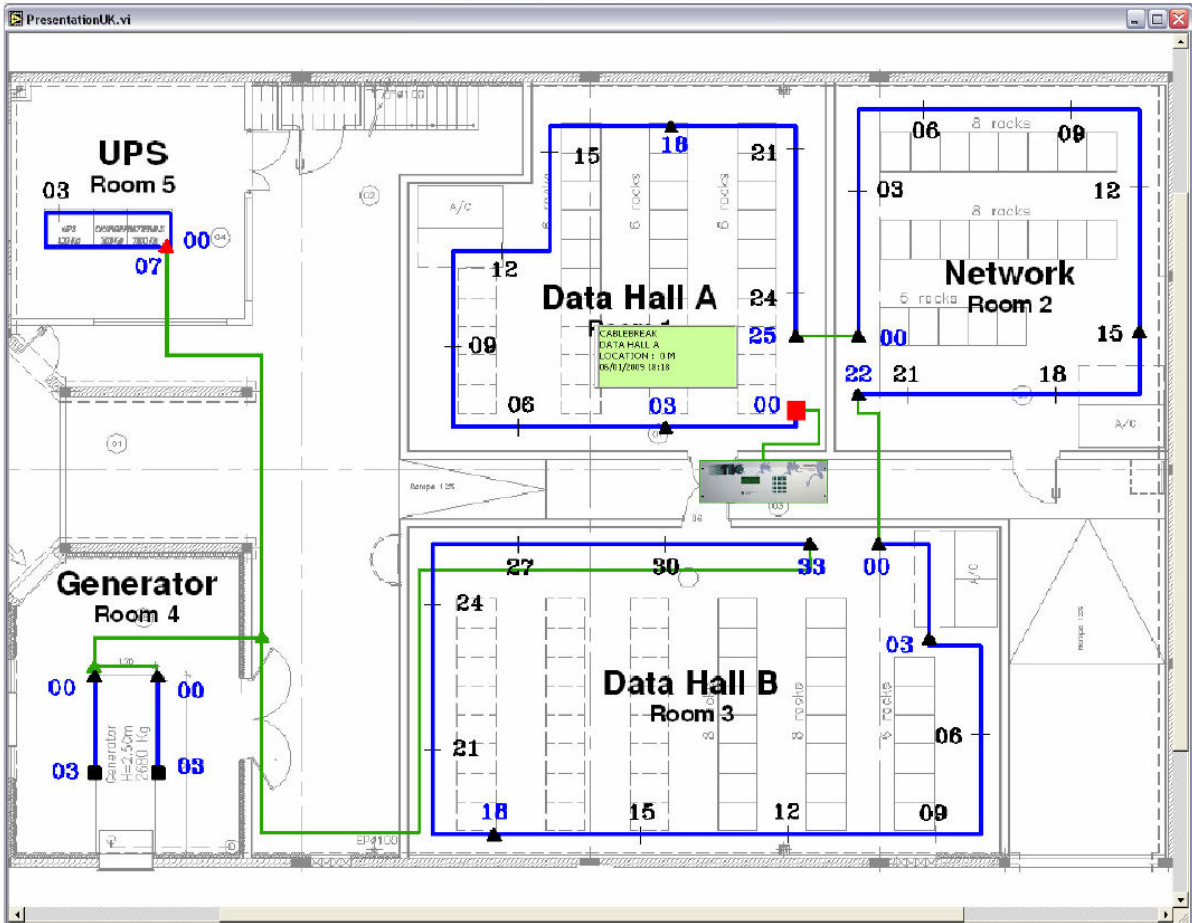

The cables in alarm status are drawn in red and the normal status cables are in blue. A small graphic window simulating the central unit display is seen just next to each sense cable in alarm status.

The maps are real-time information about a particular zone; each new event updates the information on the corresponding window. The status of each zone could also be displayed using the button Load/Update Map.

Each window of this software could be printed on a colour printer connected to the parallel port of the computer. Thus a file with different printouts could be conserved by the user to follow the overall status of the liquid leaks on the site.

IV TEST PROCEDURE

All the material was installed; you have just turned the FG-SYS digital unit on, it is now necessary to test the system.

1. FUNCTION TEST

The digital unit automatically carries out a general test during the powering of the system. This function TEST is also available from the MONITORING mode by pressing the key [T].

An audible alarm sounds and the luminous witness becomes red, it turns green and the display indicates that the circuits are under test.

CIRCUITS UNDER TEST

The digital unit tests one circuit after the other. Three circuits of cables are available on the digital unit. In the majority of the cases only one circuit is used. The display indicates the length of each cable, as well as the overall length of all of the circuits.

```
CIRCUITS UNDER TEST
CABLE # 1:           7m
001-COMPUTER ROOM 1
TOTAL CIRCUIT:      7m
```

```
CIRCUITS UNDER TEST
CABLE # 2:           15m
002-COMPUTER ROOM 1
TOTAL CIRCUIT:      22m
```

```
CIRCUITS UNDER TEST
CABLE # 3:           7m
003-TGBT
TOTAL CIRCUIT:      29m
```

Once the test is finished, the digital unit passes into MONITORING mode:

```
ON 14/05/2015      15:05
« SITE NAME »
UNDER SURVEILLANCE
[ H ] isto [ T ] est [ M ] enu
```

Caution: Each change on the circuit of cables (change of cable, new provision) forces you to activate the TEST procedure.

2. TEST OF LEAK

The digital unit is in monitoring mode. Simulate in several areas a leak, in order to check the correct operation of the digital unit. The accuracy of the localization is ± 1 metre to the leak.

Caution:

A fault must be present for at least 30/40 seconds before being detected by the digital unit. In the same manner, the digital unit passes again in Standby mode, 30 seconds after the physical suppression of the fault.

Put some tap water on the sense cable, over a length of 12 to 15 cm. Do not put the connector and the black sheath in water!

The red luminous witness ignites and a message of leak appears. If a relay is associated to this fault, it rocks.

LEAK COMPUTER ROOM 1 LOCALIZATION: 58 m 16/04/2015 16:29

Once the leak has been dried, it takes a few moments, a message appears displaying the end of the fault, the luminous witness becomes green, the relay rocks in to its initial position and the digital unit passes into Standby mode.

END OF FAULT COMPUTER ROOM 1 LOCALIZATION: 58 m 16/04/2015 16:34

3. TEST FOR CABLE BREAK

DISCONTINUITY TEST

There are three types of discontinuities:

1. **Bus discontinuity**
The bus discontinuity is a loss of communication with a sense cable. It can occur when a cable is disconnected or cut. The digital unit always indicates the first cable that is no longer responding. Caution: When the end of a sense cable is disconnected, it is the next one that can no longer respond and that will be declared as a bus discontinuity. The preceding cables remain operational.
2. **Cable discontinuity**
Sense cables are composed of external wires for detection and internal wires for communication. When only the external wires are damaged, the digital unit reports a cable discontinuity. In this case, the digital unit indicates the damaged cable but all the preceding and subsequent cables remain operational.
3. **End of circuit discontinuity**
The end of circuit discontinuity indicates that the terminator plug is missing. The position of the plug is calculated automatically at startup of the system when all the cables are installed and there are no more faults. It is therefore possible to have end of circuit discontinuities at the wrong addresses during the installation and startup phases.

In this case, run a system test to view the number of sense cables recognized and find the first cable that has not replied to the digital unit.

The digital unit is in Monitoring mode. It creates a discontinuity in the cabled circuit in order to check the correct operation of the digital unit.

Disconnect the start of a sense cable in order to create a bus discontinuity on this cable. The indicator light turns red and a discontinuity message appears on the digital unit. If a dry contact is associated with this fault, it switches. The digital unit locates the faulty cable.

```
CABLEBREAK
004-TELECOM
CABLEBREAK BUS: 0 m
16/04/2015      16:33
```

Reconnect the sense cable. An end of fault message appears, the indicator light turns green, the dry contact switches back to its initial position and the digital unit switches to Monitoring mode.

```
END OF DEFAULT
004-TELECOM
CABLEBREAK BUS: 0 m
16/04/2015      16:41
```

4. DRAWING WITH FG-MAP

The map is a diagrammatic representation of the architecture of the system, for the detection and localization of leaks from any of the sense cables installed. It indicates the layout of the sense cables, neutral cables, diversion boxes and termination blocks.

The use of the drawings is essential for a good explanation of the system for detection, since they make it possible to locate effectively and quickly the fault information indicated by the digital unit.

The Laminated drawings are coloured to identify the various cables (detection or neutral), the accessories and the points there has been a simulation of a leak. Two specimens will be provided to you indicating the zones for detection. When several zones are installed on the same level, it is recommended to contemplate a plan of the level. A general drawing can also be carried out to clearly identify the protected zones.

Drawing:

The drawing identifies a series of simulated leaks; the localization of these leaks is displayed on the FG-SYS Digital Unit. Make a simulation at the remote end of all the sense cables on the circuit. Precisely note the localization given by the digital unit displayed on the LCD Digital Unit. It is easier to carry out these simulations with a suitable tool of communication (transmitting - receiver). Simulations concerning leaks must be carried out one after the other in a chronological direction. At the end of the simulations, check if the statements of points are in order with your installation. You can then carry out the drawings, using these statements of points.

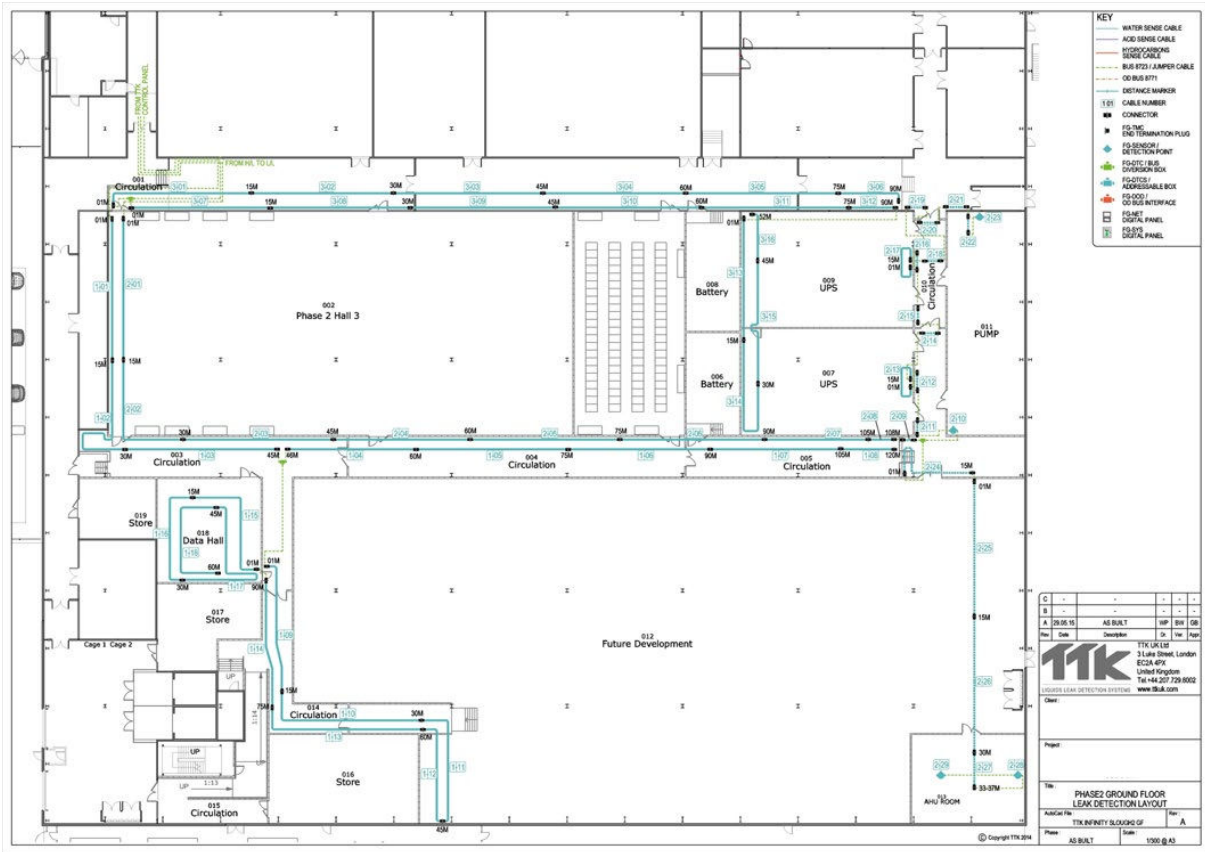

V MAINTENANCE – FAULT FINDING

1. CHECKING THE SYSTEM

It is highly recommended, to carry out a complete maintenance on the FG-SYS twice per annum. These tests make it possible to check the state of the circuits, with the sense cables, and to control the correct operation of the FG-SYS Digital Unit; this will ensure a better operation and reliability in time, for the system. These tests can be more frequently carried out in particularly exposed zones.

To activate the test procedure, and to carry out simulations for leaks and cable break, refer to the test procedure (chapter IV):

- Check the state of the hold-down clips and their fixings
- Check the position of the sense cables and their plating on the ground.
- Check the presence of the labels (signal tags) for indication on the circuits of cables
- Check the connection of the cables on the FG-SYS Digital Unit
- Check the mechanical and physical state of the FG-SYS Digital Unit
- Check the exactly the hour and the date

A report/ratio of maintenance must be written after each intervention of maintenance. TTK UK Ltd. proposes with each one of its customers a preventive maintenance contract comprising of two annual visits.

2. MAINTENANCE OF THE SYSTEM

For any handling of the central processing unit, it is imperative to power the system down. (Turn it off)

2.1 Replacement of a Sense Cable

The replacement of a sense cable is an easy and fast operation. Disconnect the two ends from the cable and replace it with the new cable. A sense cable must be replaced if it is sheared or contaminated too strongly. The traces of contamination in weak concentration on a small surface can be cleaned. Before the replacement of a sense cable, it is necessary to turn the central processing unit off. For replacement of a sense cable, it is imperative to activate the TEST procedure, by pressing on the “T” key on the main keypad.

2.2 Precautions for Use and Storage

The sense cable is mechanically resistant but remains a sensitive cable; It is necessary to respect the following procedures:

- Preserve the sense cables in their conditioning of origin in a clean and dry place.
- The installation of the sense cables must be carried out after other works on the building site are finished.
- Protect the sense cables against any risk from shearing (falls of heavy and cutting tools), any contact with heat sources or flames (welding, gas-fired warm air heater...), any contact with contaminant liquids (painting, detergent, cement...)
- During the fixing of the clips on the ground, do not to use adhesive bands; they absorb moisture and can set off alarms.

2.3 Addition of Sense Cables on an Existing Circuit

An extension of the FG-SYS Digital Unit implies either an addition of sense cables on a circuit of existing cables (maximum capacity of 40 sense cables per circuit,) or the installation of a new circuit of cables (see following paragraph). If you want to move sense cables, proceed in the same way.

- Turn the central unit off
- Add or move the sense cables
- Turn the central unit on (see paragraph III 1.)
- Check and modify the denomination of the cables in the MENU mode (see paragraph III 3.)
- Follow the procedure of test (see chapter IV)

2.4 Addition of a New Circuit of Sense Cables (Circuits n°2 and/or n°3)

If the maximum capacity of the existing circuit is reached (40 sense cables), it is necessary to install a circuit of additional cables. That requires the addition of a connecting cable for the circuit.

When the circuit n°2 is used:

- Remove the existing shunt between 2A and 2B.

When the circuit n°3 is used:

- Remove the existing shunt between 3A and 3B.

Caution: A shunt between items 1 and 2 causes a dysfunction of the digital unit.

- For the installation of the sense cables refer to chapter II
- Turn the central unit on
- Use the MENU mode to name the cables
- Follow the TEST procedure

3. TROUBLE SHOOTING GUIDE

During the test, the posted overall length not corresponding to that installed:

There is a cable damaged on the circuit. If one of wire of detection (spiral wire) is cut, the length read by the digital unit will be 15 meters whatever the real length of the sense cable. But, as soon as the test is finished, a message of cable break indicates which the damaged sense cable is.

During the powering, the sense cables installed are not read:

To check the connection of the connecting cable FG-CLC on the connector block of the digital unit. An inversion between the two couples red + black and green + white damages the electronics of the first connected sense cable.

During the powering, the digital unit does not read one of the sense cables installed:

The identified sense cable is probably defective, as well as the connector of the previous sense cable.

Leak is detected but badly localised liquid:

The precision of the localization of a leak is + / - 1 meter. If a leak is not visible in this perimeter, pay attention to the whole length of the cables. The leak cannot be on the cable upstream, or on the cable downstream; each cable is managed in an autonomous way by a chip, placed in its connector on the male end which makes them completely independent.

Message of cable break:

The display indicates the localization of a fault. Check the connections of the sense cable. If the localization is at the end of a loop, check the termination block FG-TMC. Check finally the state of the sense cable over all its length to detect a cut or a shearing.

Cable break bus:

Check the connection between the leader cable FG-CLC and the connector block on the FG-SYS Digital Unit. A short-circuit between the red wire and the black wire can cause cable break alarm.

Message of leak which appears and which disappears regularly:

The message of leak does not remain permanently registered. The threshold of contamination of the sense cable is not reached. Either there is a small leak (insufficient to set off the alarm), or the cable is polluted (dirtiness, painting, grease, bituminise...).

The keys of the keyboard do not answer any more:

Check the circuit board on the front face. It may not be connected properly to the electronic chart. To reach it, it is necessary to open the door for the metal enclosure FG-SYS F.

The audible alarm sounds continuously:

In the event of fault, the audible alarm sounds continuously.

Use the sound off button located under the green led witness; Check the flat ribbon of the panel front face.

Problem from the display:

Contrast decreases, retro-lighting is irregular; the problem can come from the power source. Please contact TTK UK Ltd., TTK Asia Ltd., or TTK S.A.S.

FG-SYS Digital Unit "blocked ":

Make a «Test », by pressing on the "T" key, on the front keypad. If after one minute, the FG-SYS Digital Unit is still blocked, turn the Digital Unit off, for at least three minutes, and then turn it on. If still no response, call TTK UK Ltd., TTK Asia Ltd., or TTK S.A.S.

TTK WIRING DIAGRAM / FG-SYS DIGITAL UNIT

